

# Catálogo de Aplicações Flexíveis de Freio Hidráulico e Direção Hidráulica



**FREIOCAR**

# Catálogo de Aplicações Flexíveis de Freio Hidráulico e Direção Hidráulica

## Índice

Freio hidráulico Ford .....	3
Freio hidráulico Volkswagen.....	14
Freio hidráulico General Motors .....	19
Freio hidráulico Fiat .....	28
Freio hidráulico Peugeot .....	32
Freio hidráulico Toyota .....	34
Freio hidráulico Asia .....	36
Freio hidráulico Vans e importados .....	39
Freio hidráulico Mercedes-Benz .....	44
Freio a ar .....	49
Direção hidráulica Ford .....	52
Direção hidráulica Volkswagen .....	66
Direção hidráulica General Motors .....	77
Direção hidráulica Fiat .....	94
Direção hidráulica Toyota .....	101
Acessórios Vans importadas .....	103
Direção Hidráulica Vans importadas .....	106
Direção Hidráulica Peugeot / Renault .....	115



# Freio Hidráulico



**FREIOCAR** 



**1001**  
2BC611775  
Versailles / Santana 94/... 185 mm



**1002**  
305611707-1  
Versailles 360 mm



**1003**  
43509-A  
Itamaraty- 405 mm



**1004**  
43510  
Itamaraty - 430 mm



**1005**  
49736  
Corcel - 338 mm



**1006**  
49737  
Corcel - 330 mm



**1007**  
547.611.707  
Escort / Logus / Pointer / Verona-94 - 458 mm



**1008**  
547.611.775-A  
Escort/Logus/Pointer/Verona-94 - 440 mm



**1009**  
77 NU 2078 A  
Corcel II/Del Rey/Belina II - 78/... 350 mm

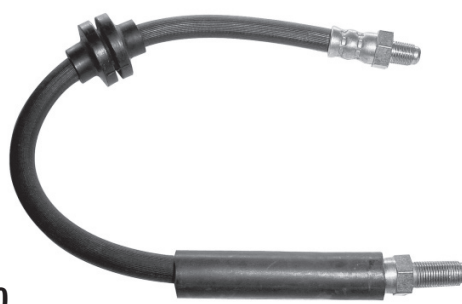

**1010**  
84 AU 2078 B  
Escort / Verona / Apollo - 406 mm



**1011**  
84 AU 2282 A  
Escort / Verona / Apollo - LD-310 mm



**1012**  
84 AU 2282 B  
Escort / Verona / Apollo - LE-310 mm



**1013**  
97KB 2078 BB  
Ford KA - Lado Esquerdo - 97/... 535 mm



**1014**  
97KB 2078 CB  
Ford KA - Lado Direito - 97/... - 535 mm



**1015**  
97KB 2282 AB  
Ford KA - 97/... - 390 mm



**1016**  
B 11587  
Aero-Willys - 405 mm



**1017**  
B 11588  
Aero-Willys - 405 mm

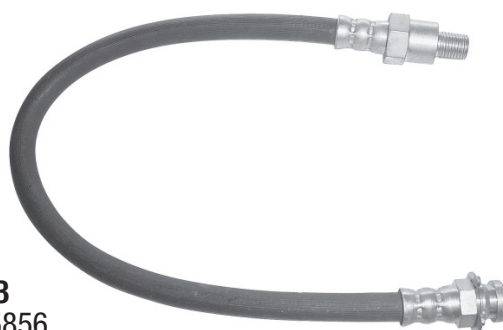

**1018**  
B 25856  
Aero-Willys - 435 mm



**1019**  
BC7A2078  
Galaxie - 315 mm



**1020**  
BC7A 2282 C  
Galaxie - 415 mm



**1021**  
BD 3A 2078 B  
Galaxie LTD / Landau Disco 72... - 390 mm



**1022**  
BD3M 2078 A  
Corcel II / Del Rey / Pampa 4x4 / Belina 78... 403 mm



**1023**  
95AB 2282 DB  
Escort 95... - 465 mm



**1024**  
97KB2078BB  
Ford Fiesta / Ford Courier 95... - Lado Direito



**1025**  
97KB2078CB  
Ford Fiesta / Ford Courier 95... - Lado Esquerdo



**1026**  
2.S62.2078 A2A  
F.H Fiesta Amazonas 2002 - 560 mm



**1027**  
2.S62.2282 A2A  
F.H Fiesta Amazonas 2002 - 370 mm



**1028**  
96.FB.2282 AC  
F.H Fiesta Sedan Após 2000 - 340 mm



**1029**  
96.FU.2282 AB  
F.H. Ford Courier Após 1999 - 430 mm



**1101**  
2 SB 607183  
F-1000 Lado Esquerdo 94... 530 mm



**1102**  
2 SB 607183-A  
F-1000 Lado Direito 94... 530 mm



**1103**  
2SH 607183  
F-4000 Lado Esquerdo 93... 660 mm

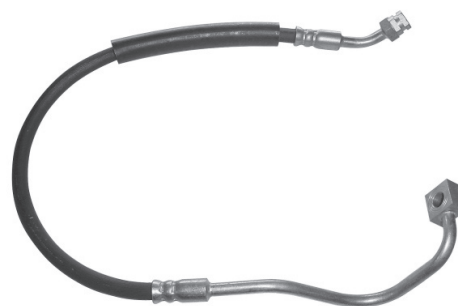

**1104**  
2SH 607183-A  
F-4000 Lado Direito 93... 660 mm



**1105**  
43509  
Pick-Up/Rural - 410 mm



**1106**  
BC7C 2078 A  
F-100 / F-1000 / Freio Tambor - 445 mm



**1107**  
82 PU 2282A  
Pampa 4x4 - 600 mm



**1108**  
83 PU 2282A  
Pampa 4x2 - 480 mm





**1109**  
85 TU 2B171 C  
F-4000 / Agrale 1800 - Lado Direito - Após 85-640 mm



**1110**  
85 TU 2B218 C  
F-4000 / Agrale 1800 - Lado Esquerdo - Após 85-640 mm



**1111**  
B 11045  
Jeep - 235 mm



**1112**  
B 11586  
Jeep - 220 mm



**1113**  
B 11587  
Pick-Up / Rural / Jeep - 405 mm



**1114**  
BD2T 2078A  
F-750 / 600 / 700 - 72/80 - 610 mm



**1115**  
BD 3B2.593A  
Jeep Willys - 301 mm



**1116**  
BDOT 2282 A  
F-700/F-1000/F-4000/F-7000/F-11000 81/92 570 mm

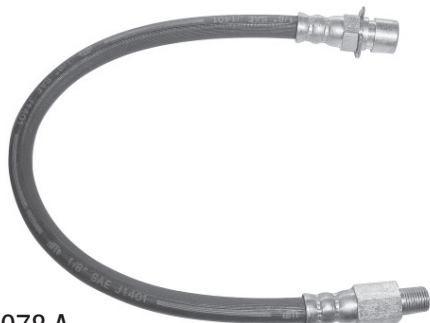

**1117**  
DB 4D 2078 A  
Freio a Disco Maverick - 405 mm



**1118**  
BEDY 2078 B  
F-4000 - 72/... - 500 mm



**1119**  
BEOB 2078 A  
F-75 / Pick-Up / Willys - 56... - 415 mm



**1120**  
BEOB 2282A  
F-75 / Rural 4x2 / 4x4 Jeep Willys - 409 mm



**1121**  
BEOC 2078 A  
F-1000 Lado Direito - 80/92 - 650 mm



**1122**  
BEOC 2078 B  
F-1000 Lado Esquerdo - 80/92 - 650 mm



**1123**  
BEOC2A566A  
Hidrovácuo F-1000 / 4000 - 265 MM



**1124**  
BEOC 2A 566 B  
Hidrovácuo F-1000 Todos - 300 mm



**1125**  
BEOT 2078 A  
F-700 / 600 / Avarentão - 81/92 - 660 mm



**1126**  
BEOY 2078 A  
Intermediário F-11000 / 4000 - 260 mm



**1127**  
BEOY 2282 B  
F-4000 - 72... - 570 mm - / F-600-56...



**1128**  
OIT 2078  
F-350 / 600 - Freio Tambor - 530 mm



**1129**  
T72 607306  
F-4000 93....- 575 mm

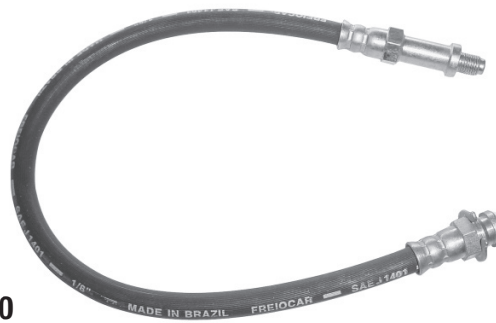

**1130**  
TAAK 2078 A  
F-100 - 485 mm

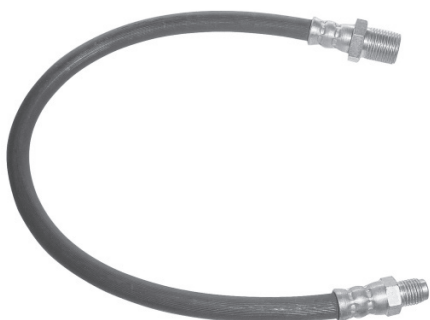

**1131**  
TBAA2078 A  
F-350 - Freio Tambor - 443 mm



**1132**  
TDAA 2078 A  
F-350 / 600 - Freio Tambor - 490 mm



**1133**  
TNK 607183  
F-1000 Lado Esquerdo 93/94 - 520 mm



**1134**  
TNK 607183-A  
F-1000 Lado Direito - 93/94 - 520 mm



**1135**  
F-2000 / Agrale 1600 - 585 mm



**1136**  
Flex.F.H. Micro-Ônibus Volare Lado Direito

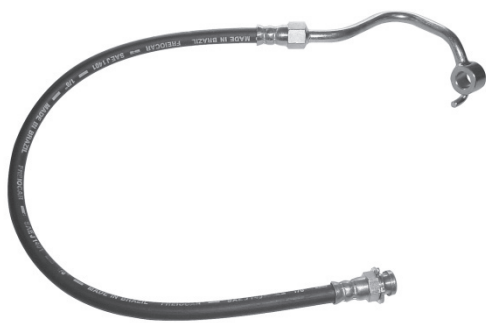

**1137**  
Flex.F.H. Micro-Ônibus Volare Lado Esquerdo



**1138**  
6006005013009  
F.H. Micro Ônibus Volare - 555 mm



**1139**  
81 Z 2078 BA  
F.H. F250 / F350 / ABS - Lado Direito - 560 mm



**1140**  
81 Z 2078 GB  
F.H. F250 / F350 / ABS - Lado Esquerdo - 560 mm



**1141**  
2N152282-BC  
Eco Sport 4x4



**1142**  
2N152282-AB  
Eco Sport 4x2



**1143**  
F81Z2078-BB  
F250 / F350 / F4000 Lado Esquerdo - 99...

## Freio Hidráulico



**FREIOCAR** 

## Freio hidráulico Volkswagen auto



**1201**  
113.611.701  
Sedan 1200 / 1300 / 1500 / TL / K Guia - 480 mm



**1202**  
113.611.775.2  
Kombi 1500 (2 Lados) 1600 Lado Esquerdo/Brasília 73 - 285 mm



**1203**  
113.611.775.3  
Sedan/Kombi 1200 / 1300 / 1500 / Cliper Esq./  
Brasília / TL / TC - 265 mm



**1204**  
1 HO 611.701  
Golf GTI / GL / GLX / GLM - 490 mm



**1205**  
211.611.701.2  
Kombi 1200 / 1300 / 1500 / Cliper.../82 - 440 mm



**1206**  
211.611.701-3  
Kombi Disco todas - 82... - 370 mm



**1207**  
211.611.775.1  
Kombi 1600 / Cliper Dir. / Kombi Diesel Dir. - 290 mm



**1208**  
231.611.775-1  
Kombi Diesel Esquerdo - 295 mm

## Freio hidráulico Volkswagen auto



**1209**  
2 BC 611.775  
Santana / Versailles - 94... - 185 mm



**1210**  
303.611.775-1  
Gol Ar Após 12/82/Gol Água/Voyage/Saveiro/Parati-todos-300 mm



**1211**  
305.611.707-1  
Gol / Quantum / Voyage / Passat - 360 mm



**1212**  
305.611.707.1  
Gol/ Voyage



**1213**  
305.611.775.1  
Gol Ar / Quantum / Passat - 240 mm



**1214**  
311.611.701.3  
Sedan 1500 / 1600 / Brasília / Variant / TC TL-355 mm



**1215**  
311.611.701-A  
1300L / 1500 (fr. Iona) Variant - 380 mm



**1216**  
377.611.775-B  
Gol 95... - 220 mm



## Freio hidráulico Volkswagen auto



**1217**  
893.611.775-A  
Golf GTI / GL / GLX / GLM / Passat 2.8 - 190 mm



**1218**  
ZBA 611.707  
Passat - 74... - 340 mm

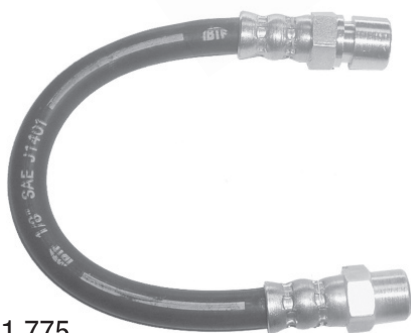

**1219**  
ZBA.611.775  
Passat/Todos - 240 mm



**1301**  
T 06.611.701  
Volks 6.80 / 6.90 / 7.110S - 640 mm

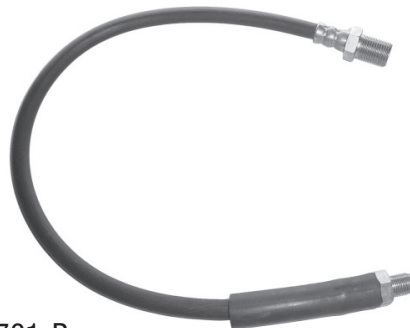

**1302**  
T 06.611.701-B  
Volks 690 / 711 / 680 - 565 mm



**1303**  
T 16.607.306  
Volks - ...94

# Freio Hidráulico



**FREIOCAR** 



**1401**  
3.434.171  
Chevette 73/79 - 380 mm



**1402**  
3.696.551  
Opala / Caravan / Comodoro - 69/79 4 e 6 cil. - 460 mm



**1403**  
7.323.868  
Opala/Caravan/Comodoro - 69/79 4 e 6 cil. - 640 mm



**1404**  
8.982.399  
Chevette 73/78 Todos - 280 mm



**1405**  
8.982.418  
Chevette 73/75 (disco) - 400 mm

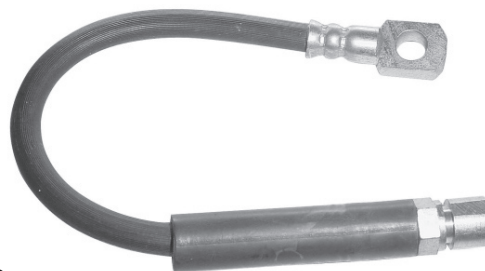

**1406**  
52.277.463  
Monza / Kadett / Ipanema 88...- 350 mm



**1407**  
90.121.718  
Monza 82/87 - 240 mm

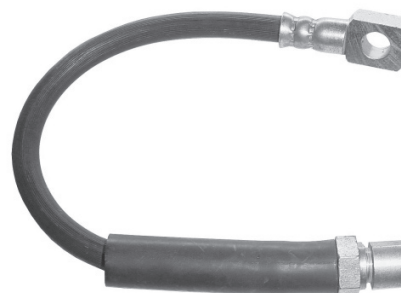

**1408**  
90.147.349  
Monza 82/87 - 335 mm



**1409**  
90.235.999  
Monza / Kadett 88... - 230 mm



**1410**  
90.445.758  
Corsa / Vectra 235 mm



**1411**  
90.445.764  
Omega 93... - Todos - 454 mm



**1412**  
90.473.452  
Corsa - 350 mm



**1413**  
90.495.787  
Vectra 97... - 424 mm



**1414**  
94.602.614  
Chevette 79... / Chevy 80/86 - 290 mm



**1415**  
94.602.615  
Chevette 79... (disco) - 390 mm



**1416**  
94.607.730  
Opala / Caravan 80 (disco) - 405 mm

## Freio hidráulico GM auto



**1417**  
94.609.698  
Opala / Caravan 80 (disco) - 650 mm



**1418**  
94.651.666  
Chevette 87...-280 mm



**1419**  
94.651.667  
Chevette 87... - 380 mm



**1420**  
52.287.187  
Opala a Disco

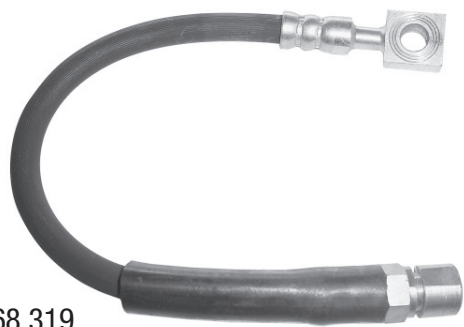

**1421**  
90.468.319  
Vectra 94/96 - 350 mm



**1422**  
93.258.704  
Freio Hidráulico Kadett 97... 365 mm



**1423**  
90.445.761  
F.H. Pick-up Corsa - 420 mm



**1424**  
90.498.319  
Astra 99/... - 430 mm

## Freio hidráulico GM auto



**1425**  
90.495.787  
Vectra 99/... - 430 mm



**1426**  
93.364.969  
Celta / Corsa - 94/... / Vectra - 97/... - 240 mm



**1427**  
93.313.709  
Astra 99/... - 245 mm

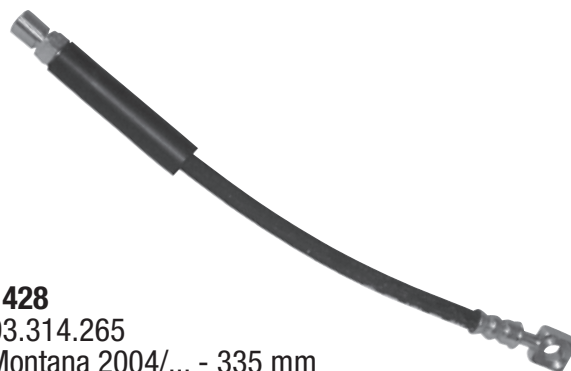

**1428**  
93.314.265  
Montana 2004/... - 335 mm

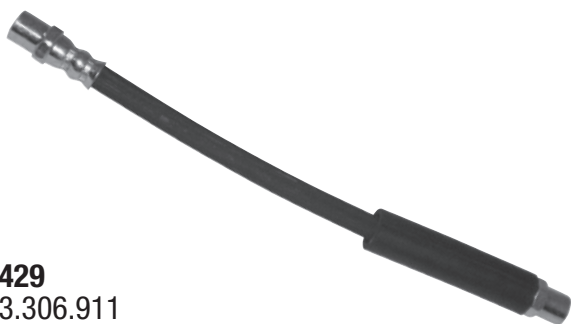

**1429**  
93.306.911  
Montana 2004/... - 265 mm



**1430**  
52.267.770  
Monza/Kadet - Freio a disco - 197 mm



**1501**  
3.696.551  
C-10 64/70 -460 mm



**1502**  
3.748.879  
Chevrolet Brasil /A/C/D-60 - 3º eixo - 510 mm



**1503**  
3.748.880  
Chevrolet Brasil /A/C/D-60 Série 6000 - Todos - 482 mm



**1504**  
3.773.168  
C-10 / C1404 / C1414 / C1416 / C1504 / Veraneio  
64/73 2ª Série - (lona) - 340 mm

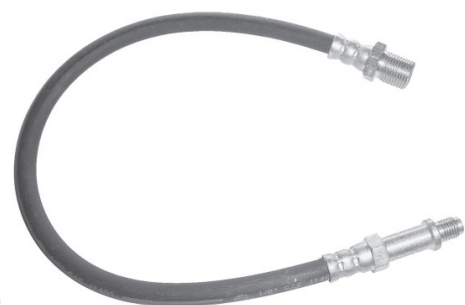

**1505**  
3.821.244  
Veraneio/C14/C1416/C1504 64/79 2ª Série - 500 mm



**1506**  
7.327.502  
C-10/ C15/ Veraneio 70/79 1ª Série C-14  
Todos - 395 mm



**1507**  
7.330.971  
C-10 / C14 / C15 / Veraneio 73/79 1ª Série  
Todos - (lona) - 340 mm



**1508**  
9.298.633  
A/C/D-10 79/84 A/C-14 85/89 - (disco) - 800 mm





**1509**  
9.306.386  
Chevrolet Brasil/A/D-60/ C10 - 77/79  
Série 6000 - 586 mm



**1510**  
93.205.823  
D-20 93... L.Esq./Silverado - 680 mm



**1511**  
93.205.824  
D-20 93... Lado Direito / Silverado - 680 mm



**1512**  
93.206.293  
D-20/Bonanza 93... - 460 mm



**1513**  
93.219.197  
S-10 95... / Blaser 95... Lado Esquerdo - 585 mm



**1514**  
93.219.198  
S-10 95... / Blaser 95... Lado Direito - 585 mm



**1515**  
93.219.200  
S-10 / Blazer - 95... - 645 mm



**1516**  
94.609.731  
Caminhão Todos 79/80 - A/C/D-60 - Série 6000 585 mm

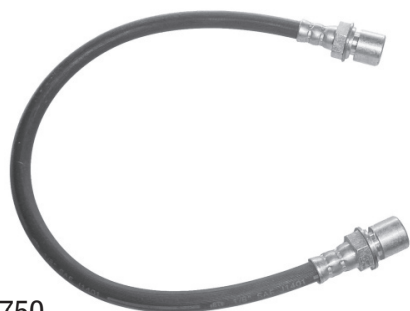

**1517**  
94.609.750  
Chevrolet Caminhão 80... A/C/D-60  
Canaveiro - 500 mm



**1518**  
94.620.079  
A/C/D-60/ A/C/D-80 - 80/84 - 450 mm



**1519**  
94.632.258  
Intermediário A/C/D-40 - 200 mm

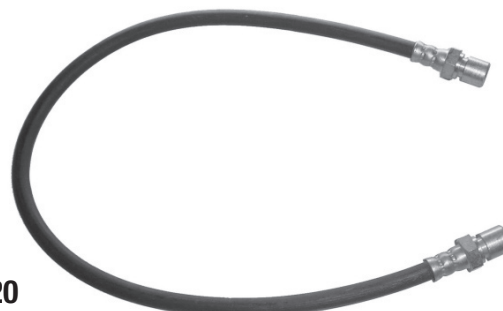

**1520**  
94.637.112  
A/C/D-60 / A/C/D-80 - 85... - 700 mm



**1521**  
94.639.060  
Inter. A/C/D-10/20 85... - 235 mm



**1522**  
94.643.089  
D-40 Lado Esquerdo - 590 mm

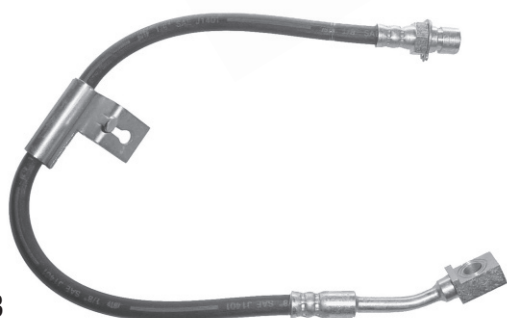

**1523**  
94.643.090  
D-40 Lado Direito - 590 mm



**1524**  
94.649.681  
Cilindro Mestre A-60 - 375 mm



**1525**  
94.657.575  
D-20 89... Lado Esquerdo - 625 mm



**1526**  
94.657.576  
D-20 89... Lado Direito - 625 mm



**1527**  
RE 00328  
Trafic - 383 mm / Trafic - 425 mm



**1528**  
RE 00347  
Trafic - 425 mm

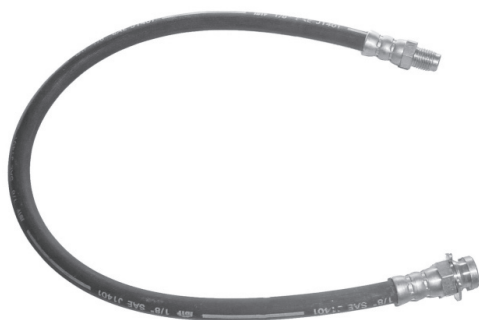

**1529**  
3.821.244  
C-14 / C-10 / C-15 - 64/70...



**1530**  
94.642.898  
S-6000 / D-40 / C-60 / A-40 - 85...

## Freio Hidráulico



**FREIOCAR** 



**1601**  
5.544.E00  
Alfa Romeo 2300 TI - Todos - 385 mm

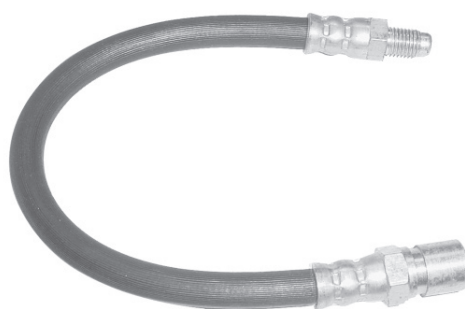

**1602**  
4.347.579  
147 / Panorama / Fiorino / Oggi ...87 - 310 mm



**1603**  
4.392.835  
147 / Panorama / Fiorino / Oggi ...87 - 265 mm

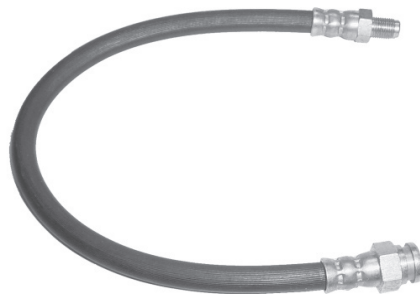

**1604**  
5.954.603  
Uno-S / CS / Premio / Fiorino / Elba ...87 - 380 mm



**1605**  
5.994.163  
Uno-S / CS / Premio / Fiorino / Elba 88... - 270 mm

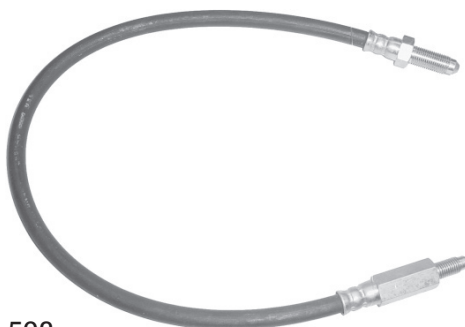

**1606**  
7.116.593  
Caminhão Fiat 70/80 - 630 mm



**1607**  
7.573.858  
Uno 91 / Fiorino 88 / Uno Mille 91... Premio/ Elba  
270 mm



**1608**  
7.706.859  
Tipo 1.6 / Tempra 16V - Intermediário - 417 mm

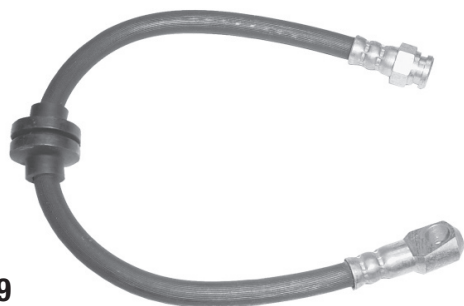

**1609**  
7.707.859  
Fiat Tipo 1.6 / Tempra 8 V Intermediário - 435 mm

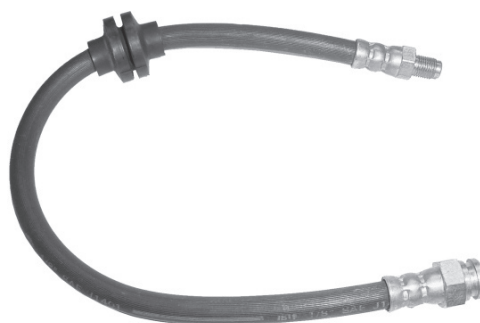

**1610**  
7.730.632  
Fiat Tipo 1.6/Tempra 8 V - 435 mm

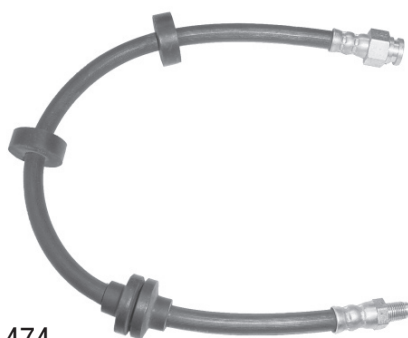

**1611**  
46.448.474  
Palio / Siena / Palio Weekend - 96... - 490 mm



**1612**  
46.456.877  
Palio / Siena / Novo Palio - 96... - 220 mm

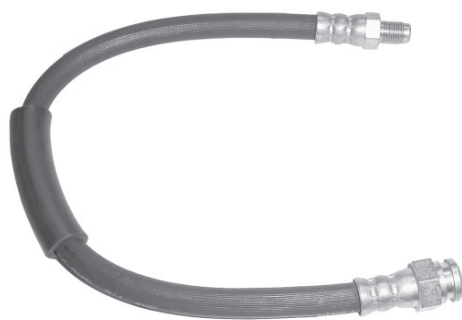

**1613**  
50.008.743  
Uno 91 / Fiorino 88 / Uno Mille 91... - 382 mm



**1614**  
97.615.764  
Tempra 16 V / Punto - 95... - 525 mm



**1615**  
7.667.806  
Tipo 1.6 / Tipo 2.0 / Marea / Marea Weekend Coupé /  
Tempra SW / Brava - 245 mm



**1616**  
93.817.105  
Iveco Daily 3510 / 4910 / 4912

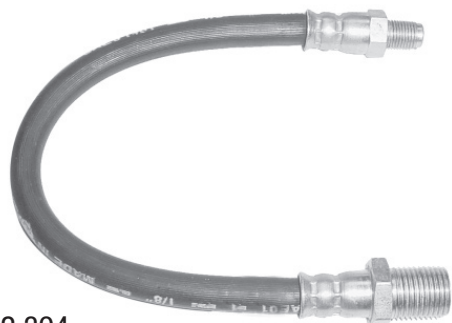

**1617**  
93.822.394  
Iveco Daiw 3510 / 4910 / 4912



**1618**  
82.442.878  
Freio Hidráulico Palio SW / Weekend - 245 mm



**1619**  
99.457.054  
Cano da Bomba D' Água Iveco Daiw

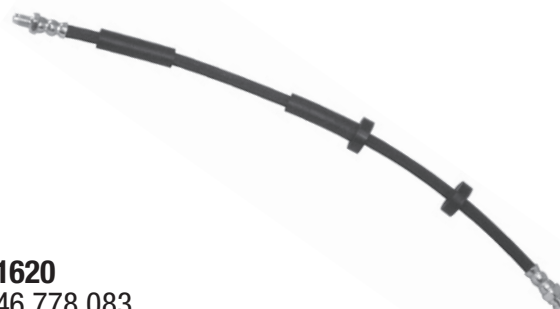

**1620**  
46.778.083  
Strada - Todas - 510 mm

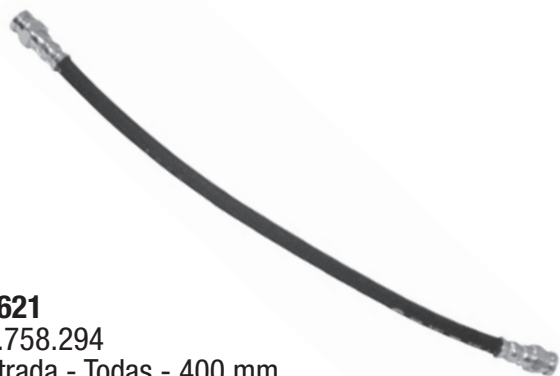

**1621**  
7.758.294  
Strada - Todas - 400 mm

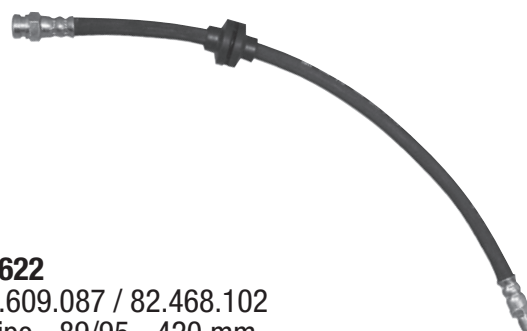

**1622**  
7.609.087 / 82.468.102  
Tipo - 89/95 - 420 mm



**1623**  
46.441.568  
Maréa / Weekend - 440 mm

## Freio Hidráulico



**PEUGEOT**

**FREIOCAR** 



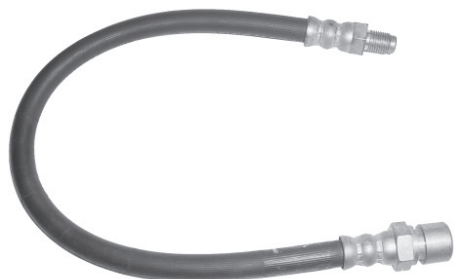

**3801**  
4806200  
Peugeot 504 - Pick-up - 395 mm

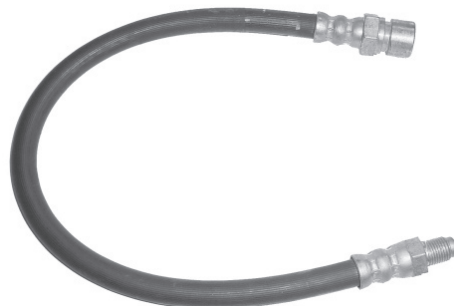

**3802**  
4806211  
Peugeot 504 - Pick-up - 395 mm

## Freio Hidráulico





**1701**  
31481/98001  
Toyota Embreagem - 415 mm



**1702**  
90029/36001  
Toyota Antigo até 09/80 - 455 mm



**1703**  
90029/36002  
Toyota Moderno após 10/80 - 450 mm



**1704**  
90029/36006  
Toyota Moderno - 386 mm



**1704-A**  
90029/36006  
Toyota Moderno - 560 mm

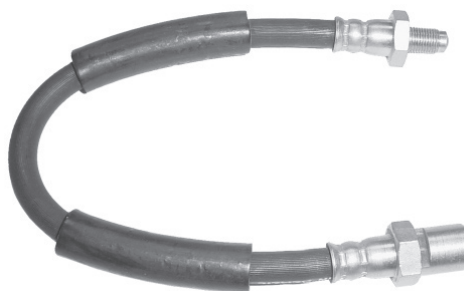

**1705**  
90029/36004  
Toyota Moderno - 340 mm



**1709**  
90947/02957  
Pick-Up Toyota Hylux 2002... - 355 mm



**1710**  
90947/02958  
Pick-Up Toyota Hylux 2002... - 370 mm

## Freio Hidráulico





**1801**  
7.910.349  
Topic / Besta Traseiro - 297 mm



**1802**  
8.416.348  
Topic / Besta Dianteiro - 320 mm



**1803**  
AA 10043810  
Towner Dianteiro - 510 mm

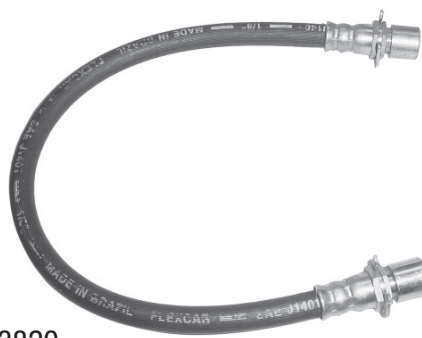

**1804**  
AA 10043820  
Towner Traseiro - 405 mm

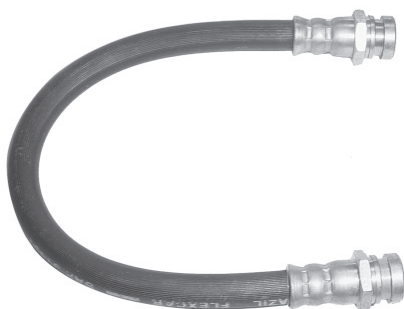

**1805**  
5881143001  
Hunday H-100 Intermediário Dianteiro - 300 mm



**1806**  
5881143002  
Hunday H-100 Intermediário Traseiro - 342 mm



**1807**  
Hunday H-100 - do tubo à pinça - 185 mm



**1807-A**  
Hunday H-100 - do tubo à pinça - 220 mm



**1808**  
3524309  
Embreagem Besta / H 100



**1809**  
Topic - 330 mm



**1810**  
OK 72F43810-C  
Besta GS 1998/2000 - Dianteiro



**1811**  
Embreagem Topic



**1812**  
1325030080  
Ducato Dianteiro

**Freio Hidráulico**

**Vans e importados**

**FREIOCAR** 

## Freio hidráulico Vans e importados



**1136**  
Flex. F.H. Micro-Ônibus Volare  
Lado Direito



**1137**  
Flex.F.H. Micro-Ônibus Volare - Lado Esquerdo



**1527**  
RE 00328  
Trafic - 383 mm



**1528**  
RE 00347  
Trafic - 425 mm

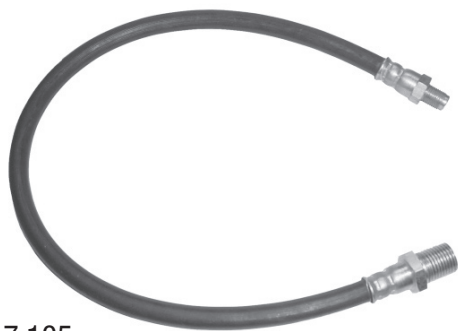

**1616**  
93.817.105  
Iveco Daily 3510 / 4910 / 4912

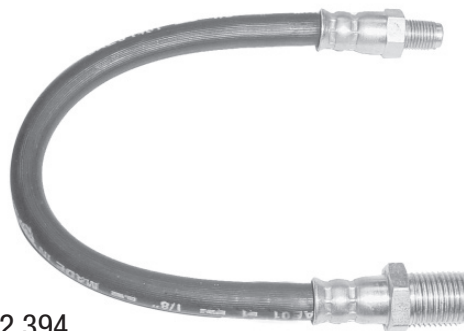

**1617**  
93.822.394  
Iveco Daily 3510 / 4910 / 4912



**1801**  
7.910.349  
Topic / Besta Traseiro - 297 mm

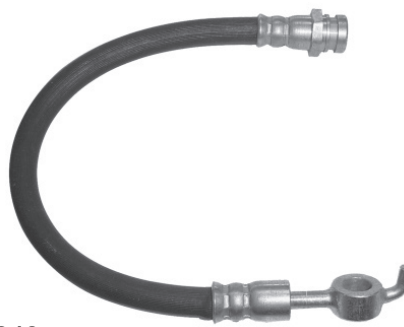

**1802**  
8.416.348  
Topic / Besta Dianteiro - 320 mm



## Freio hidráulico Vans e importados



**1803**  
AA 10043810  
Towner Dianteiro - 510 mm

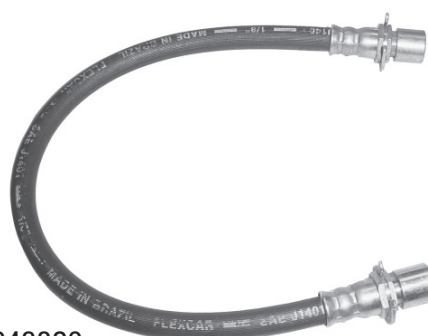

**1804**  
AA 10043820  
Towner Traseiro - 405 mm



**1805**  
5881143001  
Hunday H-100 Intermediário Dianteiro - 300 mm



**1806**  
5881143002  
Hunday H-100 Intermediário Traseiro - 342 mm



**1807**  
Hunday H-100 - do tubo à pinça - 185 mm



**1808**  
3524309  
Embreagem Besta / H 100



**1809**  
Topic - 330 mm

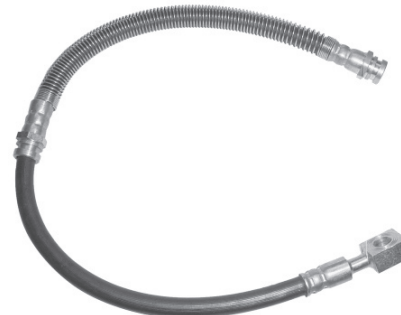

**1810**  
OK 72F43810-C  
Besta GS-1998/2000 Dianteiro

## Freio hidráulico Vans e importados



**1811**  
Embreagem Topic



**1812**  
1325030080  
Ducato Dianteiro



**1813**  
MR 129742  
Mitsubish L-200 Dianteiro



**1814**  
MR 129795  
Mitsubish L-200 Traseiro



**1815**  
46.210-8Z500  
Pick-up Nissan 2002... Dianteiro



**1816**  
46.211.8Z500  
Pick-up Nissan 2002... Dianteiro



**1817**  
46.211-025710  
Pick-up Nissan 2002... Traseiro

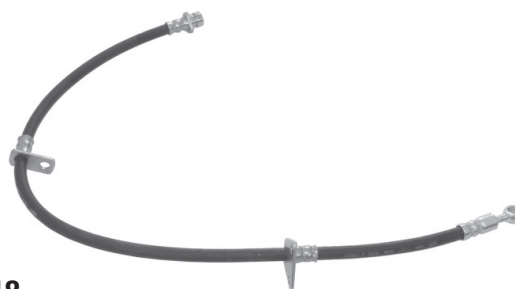

**1818**  
OSK-52011  
Honda Civic - Freio Hidráulico

## Freio hidráulico Vans e importados



**1819**  
Flexível Freio Jeep Suzuki Vitara - Traseiro 550 mm p.p.



**1820**  
Flexível Freio Jeep Suzuki Vitara - Dianteiro 800 mm p.p.



**1913**  
631.428.0035  
MB 180-D - 385 mm



**1914**  
631.428.0335  
MB 180-D - 390 mm

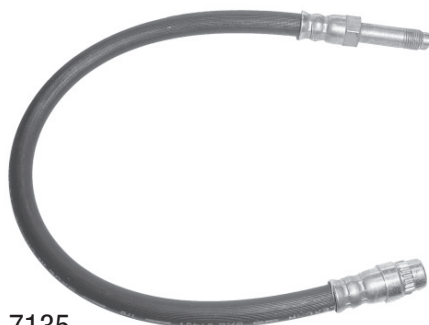

**1918**  
690.428.7135  
Sprinter - 430 mm



**1919**  
690.428.7235  
Sprinter - 485 mm

## Freio Hidráulico



**FREIOCAR** 

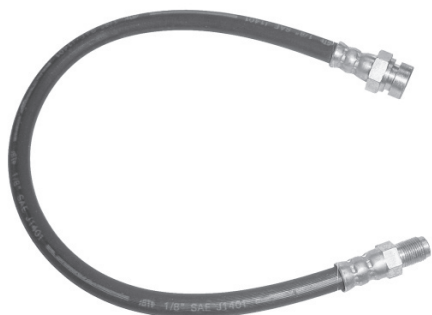

**1901**  
000.428.0135  
L/LO/608 76... /L/LA/LS/1111-OH 326/55 - 480 mm

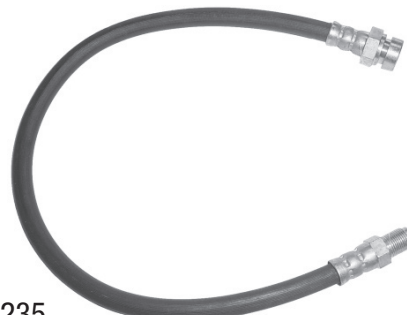

**1902**  
000.428.0235  
L/LK-1313/1116 HML/OH/LPA-321/355/364 OH-  
1313/1513 - 500 mm

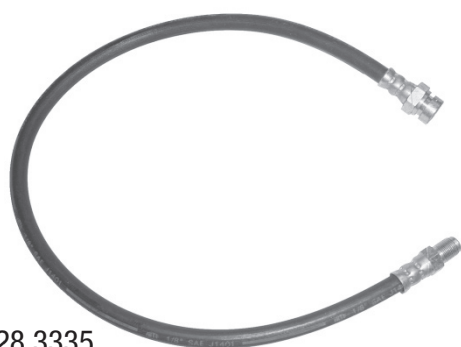

**1903**  
000.428.3335  
L 2213 - 650 mm

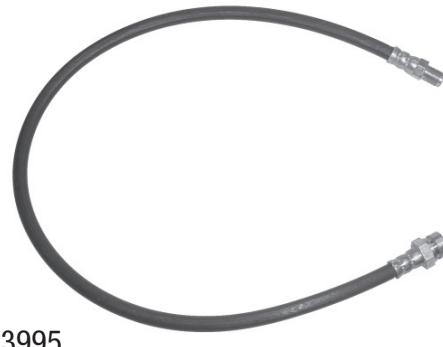

**1904**  
000.428.3995  
OH 1313 - Todos - 750 mm

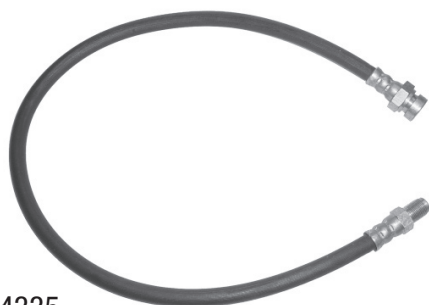

**1905**  
000.428.4335  
L/LS/LK/LPO 1113/1116/1313/1513/1519/1316  
- 627 mm



**1906**  
000.428.4735  
L/LPO-111/113/1313/1316/1516/2016/2216 - 560 mm



**1907**  
000.428.6935  
OH 1517/1313/1316 - 600 mm



**1908**  
000.428.7635  
L/LO/608/708 - 535 mm



**1909**  
000.428.8735  
OF/OH/1313/1513/L/LA/LK/LAK 1313/1318/1513  
- 627 mm

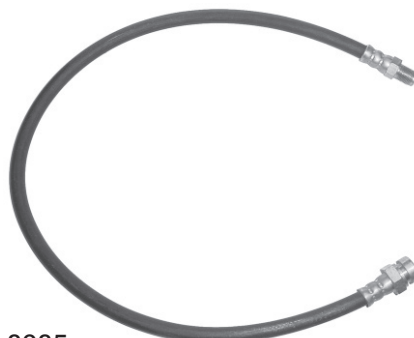

**1910**  
000.428.8935  
L/LA/LK/LAK/1313/1314/1318/1317/LA 1113 - 676 mm



**1911**  
001.428.1535  
OH 1313 / L 1513 / 1313 - 800 mm



**1912**  
364.428.7235  
0321/362/364/355 - 410 mm



**1913**  
631.428.0035  
MB 180-D - 385 mm

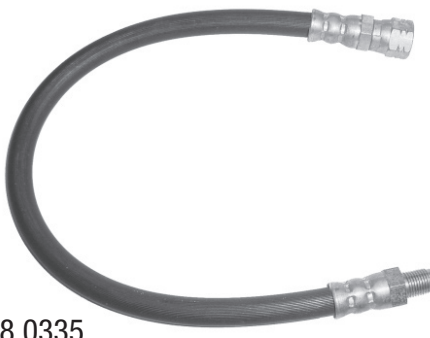

**1914**  
631.428.0335  
MB 180-D - 390 mm

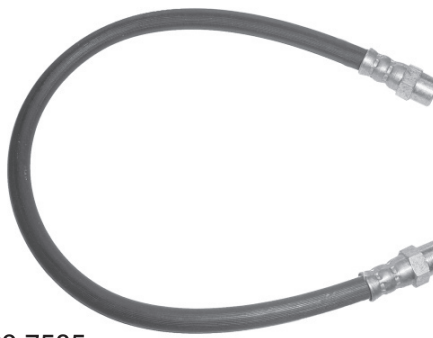

**1915**  
688.429.7535  
L/LO 709/812/912 - 490 mm

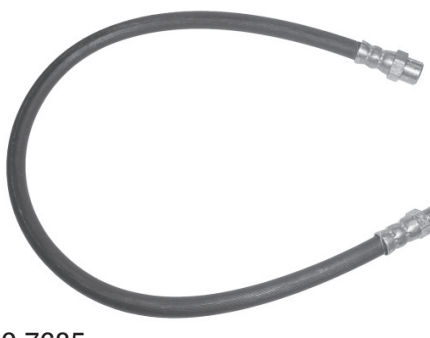

**1916**  
688.429.7635  
L/LO 709/812/912 - 575 mm

## Freio hidráulico Mercedes Benz



**1917**  
309.295.0035  
Embreagem 608-D - 325 mm



**1918**  
690.428.7135  
Sprinter - 430 mm



**1919**  
690.428.7235  
Sprinter - 485 mm



**1920**  
688.295.0035  
Embreagem MB 709



**1921**  
916031.00009  
Embreagem MB 180-D



**1922**  
376.295.7035  
Embreagem MB 1518/1318 - 217mm



**1923**  
376.295.7135  
Embreagem 1935



**1924**  
000.428.9135  
Flexível Freio Hidráulico Caminhão 1519/1520 - 590 mm



**1925**  
002.951.1735  
Embregem 608-D - 232 mm

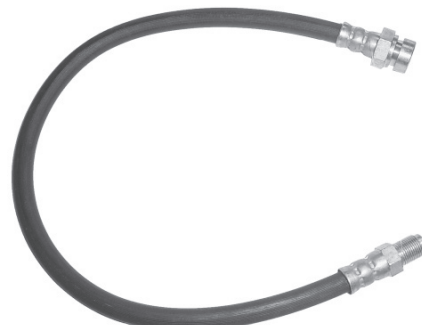

**1926**  
350.295.7135  
Embregem 1932/1933/1934 - 450 mm



**1927**  
308.428.7335 / 002.428.0535  
Freio Hidráulico MBB - 535 mm



**1928**  
901.428.0435  
Freio Dianteiro Sprinter 311/313 - 2002... - 415 mm



**1929**  
002.2380182  
Mangueira bomba de vácuo Sprinter 310



**1930**  
000.2380282  
Mangueira bomba vácuo/carter Sprinter 312 - Todas



## Freio a Ar



## Freio à Ar Bendix Antigo



<b>2001</b>	650 mm	IDEROL/RANDON/RODOVIÁRIA/FACCHINI
<b>2002</b>	700 mm	IDEROL/RANDON/RODOVIÁRIA/FACCHINI
<b>2003</b>	750 mm	IDEROL/RANDON/RODOVIÁRIA/FACCHINI
<b>2004</b>	800 mm	IDEROL/RANDON/RODOVIÁRIA/FACCHINI
<b>2005</b>	850 mm	IDEROL/RANDON/RODOVIÁRIA/FACCHINI
<b>2006</b>	900 mm	IDEROL/RANDON/RODOVIÁRIA/FACCHINI
<b>2007</b>	950 mm	IDEROL/RANDON/RODOVIÁRIA/FACCHINI
<b>2008</b>	1000 mm	IDEROL/RANDON/RODOVIÁRIA/FACCHINI
<b>2009</b>	1100 mm	IDEROL/RANDON/RODOVIÁRIA/FACCHINI
<b>2010</b>	1200 mm	IDEROL/RANDON/RODOVIÁRIA/FACCHINI
<b>2011</b>	3500 mm	Cavalo Mecânico c/ Molas Pressada
<b>2012</b>	1800 mm	Cavalo Mecânico c/ Molas Pressada
<b>2013</b>	4500 mm	Cavalo Mecânico c/ Molas Pressada
<b>2014</b>	4000 mm	Cavalo Mecânico c/ Molas Pressada
<b>2015</b>	1200 mm	Cavalo Mecânico c/ Molas Pressada
<b>2016</b>		Randon Canavieiro

## Freio à Ar Bendix Moderno



<b>2101</b>	650 mm	IDEROL/RANDON/RODOVIÁRIA/FACCHINI
<b>2102</b>	700 mm	IDEROL/RANDON/RODOVIÁRIA/FACCHINI
<b>2103</b>	750 mm	IDEROL/RANDON/RODOVIÁRIA/FACCHINI
<b>2104</b>	800 mm	IDEROL/RANDON/RODOVIÁRIA/FACCHINI
<b>2105</b>	850 mm	IDEROL/RANDON/RODOVIÁRIA/FACCHINI
<b>2106</b>	900 mm	IDEROL/RANDON/RODOVIÁRIA/FACCHINI
<b>2107</b>	950 mm	IDEROL/RANDON/RODOVIÁRIA/FACCHINI
<b>2108</b>	1000 mm	IDEROL/RANDON/RODOVIÁRIA/FACCHINI
<b>2109</b>	1100 mm	IDEROL/RANDON/RODOVIÁRIA/FACCHINI
<b>2110</b>	1200 mm	IDEROL/RANDON/RODOVIÁRIA/FACCHINI

## Freio à Ar Bendix Moderno

Fêmea Giratória 18 mm x 1,5 Boleado x Macho Rosca 16 mm

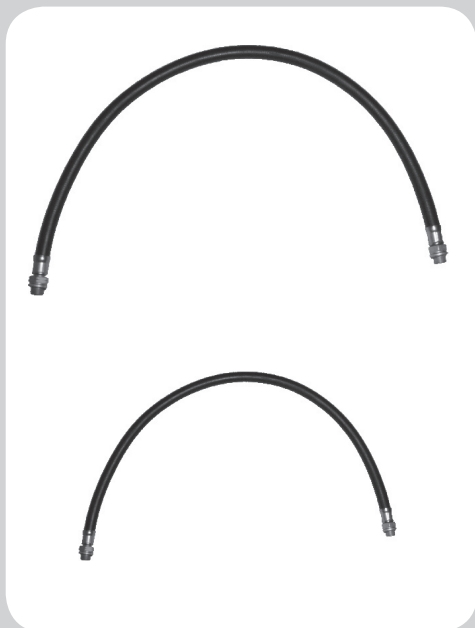

2201	650 mm	RANDON
2202	700 mm	RANDON
2203	750 mm	RANDON
2204	800 mm	RANDON
2205	850 mm	RANDON
2206	900 mm	RANDON
2207	950 mm	RANDON
2208	1000 mm	RANDON
2209	1100 mm	RANDON
2210	1200 mm	RANDON

## Freio à Ar Bendix Moderno

Fêmea Giratória 18 mm x 1,5 Boleado x Macho Rosca 16 mm x 1,5 (cônico)

2201-A	650 mm	FACCHINI
2202-A	700 mm	FACCHINI
2203-A	750 mm	FACCHINI
2204-A	800 mm	FACCHINI
2205-A	850 mm	FACCHINI
2206-A	900 mm	FACCHINI
2207-A	950 mm	FACCHINI
2208-A	1000 mm	FACCHINI
2209-A	1100 mm	FACCHINI
2210-A	1200 mm	FACCHINI

## Freio à Ar Bendix Moderno

Fêmea Giratória 18 mm x 1,5 Boleado x Macho Rosca 16 mm x 1,5 (cônico)

2201-B	650 mm	RANDON
2202-B	700 mm	RANDON
2203-B	750 mm	RANDON
2204-B	800 mm	RANDON
2205-B	850 mm	RANDON
2206-B	900 mm	RANDON
2207-B	950 mm	RANDON
2208-B	1000 mm	RANDON
2209-B	1100 mm	RANDON
2210-B	1200 mm	RANDON

## Direção Hidráulica



**FREIOCAR** 



**2301**  
Flexível Direção Hidráulica Galaxie/Landau



**2302**  
542422891  
Flexível Direção Hidráulica Escort / Caixa Argentina



**2303**  
542422893  
Flexível Direção Hidráulica Escort Lado  
Bba. Argentino



**2304**  
542.422.893-A  
Flexível Retorno Direção Hidráulica Escort  
Bba. Argentina

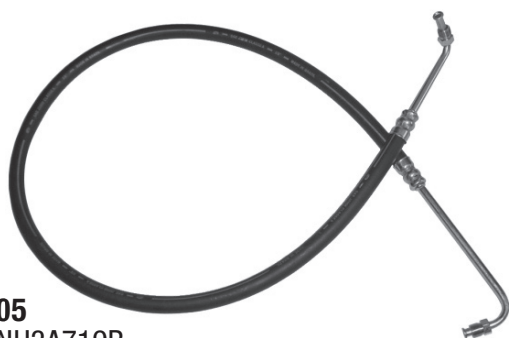

**2305**  
79NU3A719B  
Flexível Direção Hidráulica Del-Rey 1.8

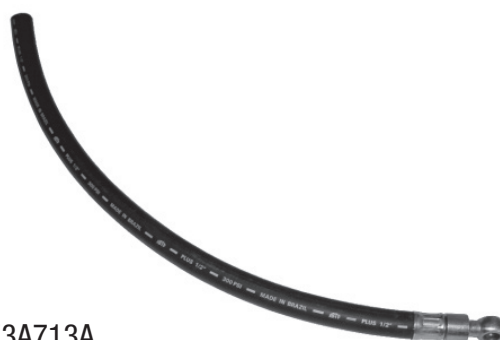

**2306**  
85NE3A713A  
Flexível Retorno Del-Rey 1.6



**2307**  
85NU3A719A  
Flexível Direção Hidráulica Del-Rey 1.6



**2308**  
85NU3E525-A  
Flexível Alimentação Del-Rey 1.6



**2309**  
89EU3A713A  
Flexível de Ret. Del-Rey 1.8 / Pampa / Belina



**2310**  
89EU3A719A  
Flexível D.H. Del-Rey 1.8 / Pampa / Belina



**2311**  
89EU3E525A  
Flexível Aliment. Del-Rey 1.8 / Pampa / Belina



**2312**  
96FB3F524CH  
Flexível Direção Hidráulica Fiesta

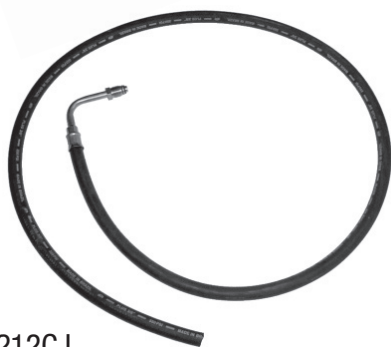

**2313**  
96FB3A212CJ  
Flexível Retorno Direção Hidráulica Fiesta 96...



**2314**  
96AB3A719AA  
Flexível Direção Hidráulica Escort Zetec 1.8



**2315**  
96AB3A691AB  
Mangueira Alimentação Escort Zetec 1.8



**2316**  
DHB 1.847.008  
Tubo de Pressão Fiesta / Courier Sem Ar



**2317**  
DHB 1.847.009  
Mangueira de Alimentação Fiesta / Courier Sem Ar



**2318**  
DBH 1.847.010  
Flexível de Pressão Fiesta / Courier Sem Ar



**2319**  
DHB 1.847.011  
Flexível de Retorno Fiesta / Courier Sem Ar



**2320**  
1.848.008  
Tubo DH Ford Ka c/ Ar e s/ Ar

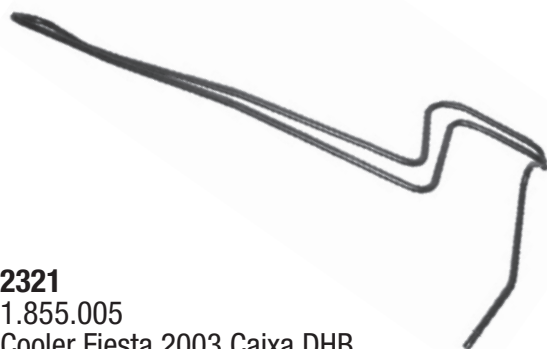

**2321**  
1.855.005  
Cooler Fiesta 2003 Caixa DHB



**2322**  
1.855.006  
Retorno Fiesta 2003 Caixa DHB



**2323**  
1.855.007  
Alimentação Fiesta 2003 Caixa DHB



**2324**  
1.885.008  
Direção Hidráulica Fiesta 2003 Caixa DHB



**2325**  
1.855.009  
Retorno Reservatório Fiesta 2003 Caixa DHB



**2326**  
1.848.004  
Tubo Direção Hidráulica Ford Ka C/Ar - Caixa DHB



**2327**  
1.848.004  
Tudo D.H. Ford Ka c/ Ar Caixa DHB



**2328**  
1.848.006  
Direção Hidráulica Ford Ka c/ Ar s/ Ar



**2329**  
1.848.007  
Retorno Ford Ka c/ Ar s/ Ar



**2330**  
96FB3A569AE  
Direção Hidráulica Fiesta 1.0 M Enduro c/ Ar - 97



**2331**  
97AG3D746AD - Retorno Mang. Moldada Lado Reservatório Escort 1.8 Zetec - 97/...

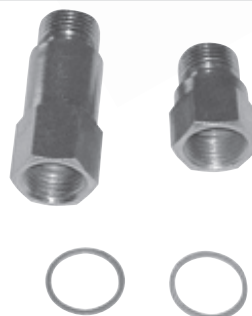

**2332**  
Kit Niple Para Adaptação Pressão / Retorno Fiesta - C/Ar - S/Ar / Ford Ka - Caixa DHB





**2333**  
97KB3691A - Manguera Reservatório Direção  
Hidráulica Ford Ka - 97/99

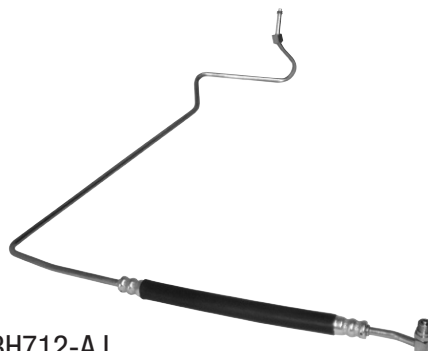

**2334**  
97KB-3H712-AJ  
Pressão Ford Ka - Zetec Rocam - 97/...



**2335**  
Pressão Ford Ka 1.0 - Motor Enduro



**2336**  
Tubo Retorno Escort Zetec

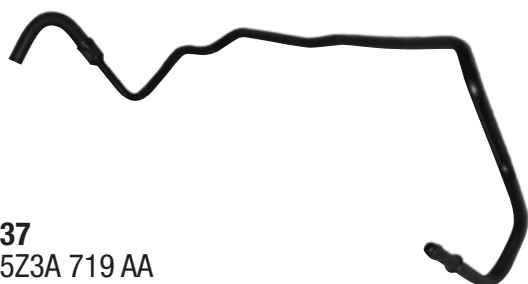

**2337**  
6E5Z3A 719 AA  
Retorno Ford Fusion 2006/...



**2338**  
6E5Z3A 713 AD  
Pressão Ford Fusion 2006/...



**2339**  
5N153F524 AA  
Pressão Eco Sport - S/Sensor

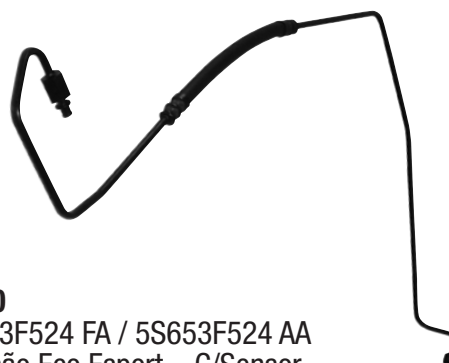

**2340**  
5S653F524 FA / 5S653F524 AA  
Pressão Eco Sport - C/Sensor

## Direção hidráulica Ford passeio



**2341**  
Retorno Ford Ka – Motor Zetec



**2342**  
Pressão Ford Ka – Motor Zetec



**2343**  
Alimentação For Ka – Motor Zetec



**2344**  
Tubo Direção Hidráulica Ford Ka

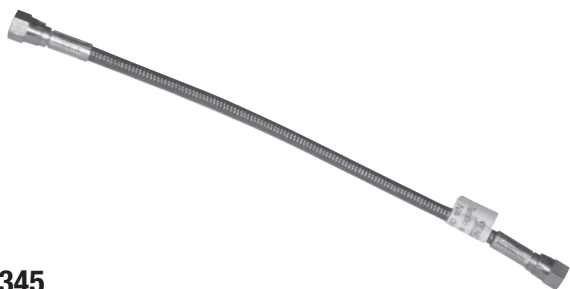

**2345**  
2T0121625-B  
Flexível Compressor Motor Cummins Volks / Ford

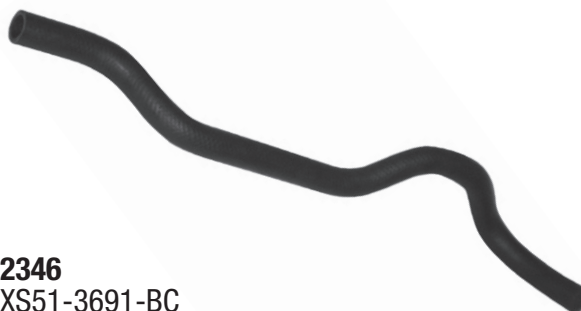

**2346**  
XS51-3691-BC  
Alimentação Ford Ka Rocan

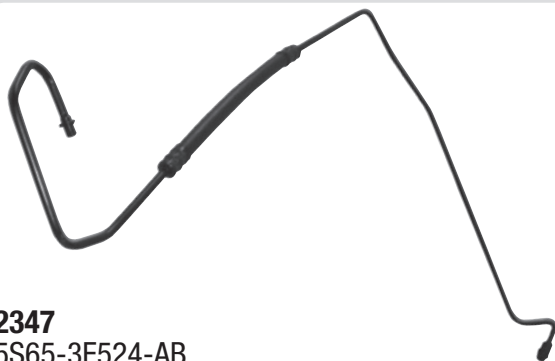

**2347**  
5S65-3F524-AB  
Pressão Fiesta Amazon – 2006/...



**2348**  
2S65-3F558-AC  
Alimentação Fiesta Amazon – 2006/...



**2349**  
2S653A713-BJ  
Retorno Fiesta Amazon – 2006/...

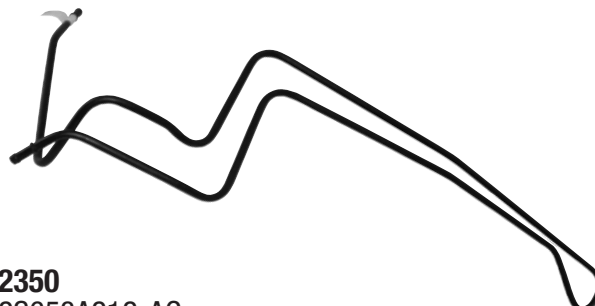

**2350**  
2S653A212-AC  
Cooler Fiesta Amazon – 2006/...



**2351**  
7S553F524-AC  
Pressão Ford Ka 2008 1.0/1.6 - Zetec Rocam



**2352**  
7S553A713-AC  
Retorno Ford Ka 2008 1.0/1.6 - Zetec Rocam

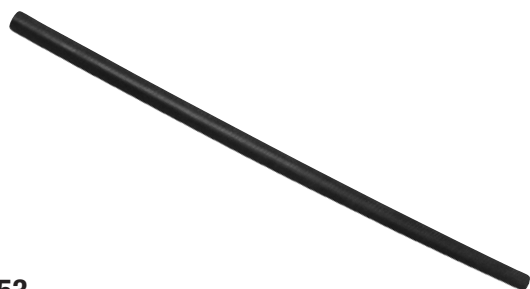

**2353**  
7S553F558-AA  
Retorno Ford Ka 2008 1.0/1.6 - Zetec Rocam



**2354**  
7S553E525-AB  
Alimentação Ford Ka 2008 1.0/1.6 - Zetec Rocam

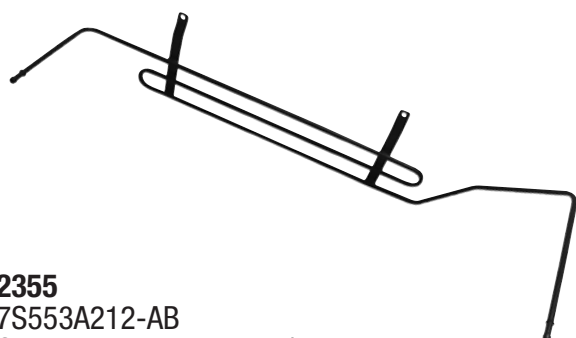

**2355**  
7S553A212-AB  
Cooler Ford Ka 2008 1.0/1.6 - Zetec Rocam



**2356**  
25653E525BE  
Alimentação Fiesta Super Charger 1.0 c/ ar

**2357**

58AG34719JL/JK

Pressão Focus 1.8 / 2.0 16 V - 2000 / 2005

**2358**

98AG36911A/ED

Alimentação Focus 1.8 / 2.0 16V - 2000 / 2005



**2359**

98AG3A713A1/AG

Retorno Lado Caixa Focus 1.8 16V - 2000 / 2007

**2360**

55453A719AC/AB

Pressão Focus 2.0 16V - 2005 / 2008



**2361**

55453A713AA

Retorno Lado Caixa Focus 2.0 16V - 2005/2008



**2362**

55453A493/AB/AA

Retorno Lado Reservatório Focus 2.0 16V - 2005 / 2008

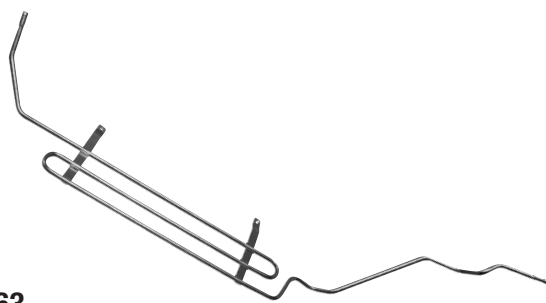

**2363**

98AG3D746BG

Cooler Focus 2.0 16V - 2000 / 2008

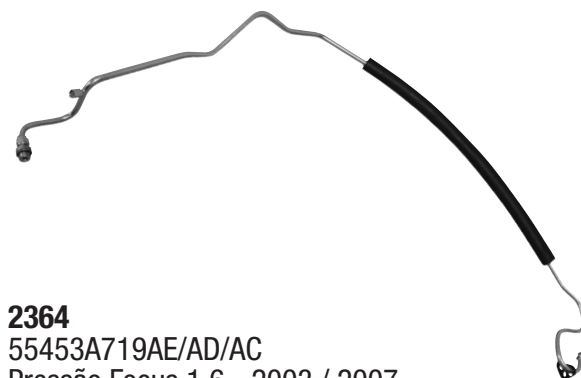

**2364**

55453A719AE/AD/AC

Pressão Focus 1.6 - 2003 / 2007



**2365**  
5413A713AA  
Retorno Lado Caixa Focus 1.6 - 2001 /...

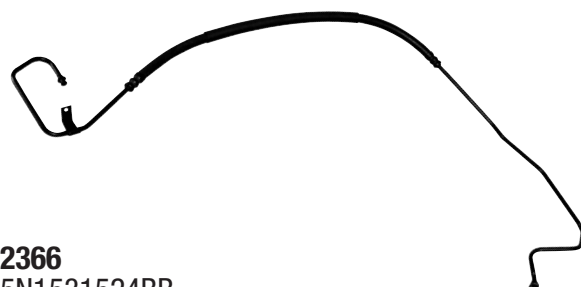

**2366**  
5N1531524BB  
Pressão Eco Sport 2.0 16V - 2006/...

## Direção hidráulica Ford utilitários



**2401**  
F47A3A719BB / F0TZ3A719A  
Flexível Direção Hidráulica Ford Ranger 6 Cil.



**2402**  
T3T23A713E  
Flexível de Retorno Direção Hidráulica Ranger 6 Cil.



**2403**  
2SB145357D  
Flexível Direção Hidráulica F-4000 92...



**2404**  
B2TU3A719A  
Flexível Direção Hidráulica F-4000



**2405**  
BD7t3691-A  
Mangueira do Reservatório Bba. F-1000 ...84



**2406**  
BDC369A  
Mangueira Retorno Direção Hidráulica F-4000/1000/  
2000



**2407**  
BE0C3A719B / BE2Y3A719A  
Flexível Direção Hidráulica F-1000



**2408**  
BE0T3A005B  
Mangueira do Retorno F-1000



**2409**  
BE0T3A719  
Flexível Direção Hidráulica F-11000 / 14000



**2410**  
T75145745  
S-14000 Sapão - Pressão 91...



**2411**  
BE3T3A719B  
Flexível Direção Hidráulica F-11000 / 13000 c/  
Motor Perkins



**2412**  
87A3719GC / F87R3A719RA  
Flexível Direção Hidráulica Ranger 4 Cil HS



**2413**  
Flexível F-1000 Importada a Gasolina



**2414**  
87HU3A714AA  
Flexível de Pressão Ford Cargo



**2415**  
Flexível de Pressão Ford Cargo 814



**2416**  
T71.145.745  
Flexível Direção Hidráulica F-1000 Motor MWM

## Direção hidráulica Ford utilitários



**2417**  
70993477  
Flexível de Lubrificação Ranger Argentina 99 Motor Perkins



**2418**  
T71145.725-B  
Direção Hidráulica Pressão F-1000 72...



**2419**  
BE373A716C  
Direção Hidráulica F1000 / F2000 / F4000

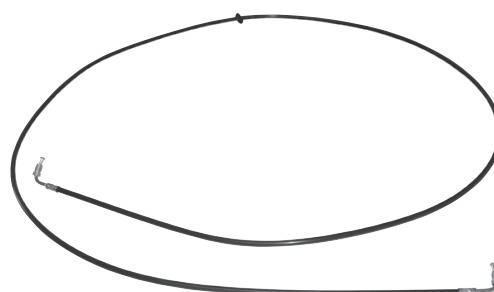

**2420**  
E7HT7K516AA / 85HU7K516A / TRA- 121.471  
Pressão Ford Cargo 1418 - 88/...



**2421**  
87 HU 2922 BA  
Flexível Lubrificação Compressor Motor Ford Cargo



**2422**  
XC 35 2A 442 BA  
Flexível Freio a Ar Ford Cargo



**2423**  
1-C-45-2917-AA  
Pressão Ford Cargo F-12000 / F-14000 / F-16000

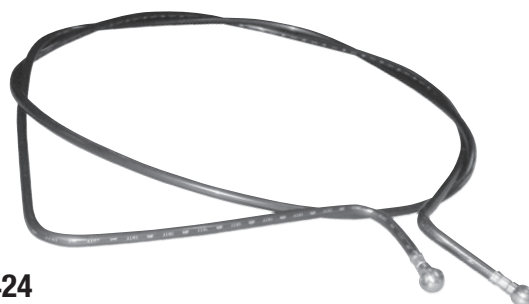

**2424**  
XC-45-7K-610-AB  
Flex. Servo Embreagem Ford Cargo 4030 / 4031 / 4331 / 1730 / 2425 / 2626 / 2630 / 2631 - 2000/...



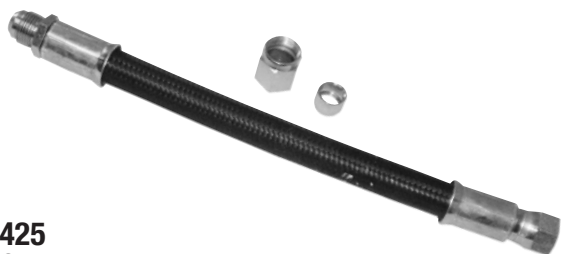

**2425**  
4C452917 AA  
Pressão F-4000

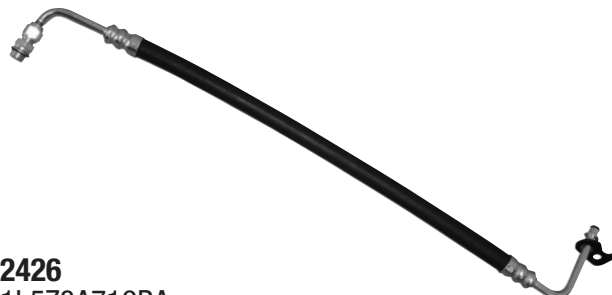

**2426**  
1L5Z3A719BA  
Pressão Ranger 4.0 - 2001 / 2003

## Direção Hidráulica



**FREIOCAR** 

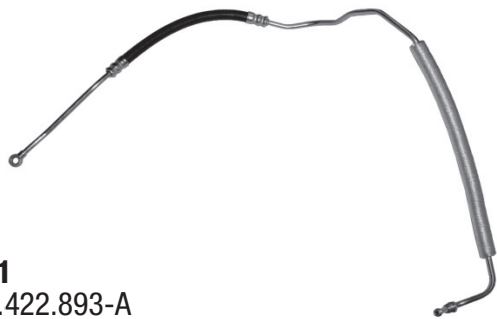

**2501**  
305.422.893-A  
Flexível Direção Hidráulica Gol / Voyage / Parati /  
Saveiro 93/97



**2502**  
325.422.891-2  
Flexível Retorno Dir. Hidráulica Santana / Quantum  
92/96 / Parati / Versailles



**2503**  
325.422.893-2  
Flexível Direção Hidráulica Santana s/ Sensor 93/98



**2504**  
325.422.893-4  
Flexível Direção Hidráulica Santana c/ Sensor 84/93



**2505**  
325.422.893-5  
Flexível Direção Santana/ Quantum 96/97 c/ Sensor



**2506**  
325.422.893-B  
Flexível Direção Hidráulica Santana 84/93 Câmbio  
Automático



**2507**  
327.422.893-1  
Flexível Direção Hidráulica Santana / Quantum 84 /  
93 s/ Sensor

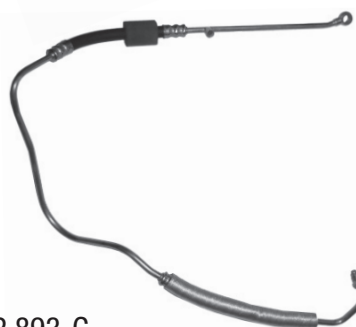

**2508**  
305.422.893-C  
Flexível Direção Hidráulica Gol 93/ 95 Caixa TRW c/  
Sensor



**2509**

377.422.893-J

Flexível Dir Hidráulica Gol 1000 / 1600 / 1800 /  
2000 EFI Digital 16v 96/00



**2510**

431.422.877-A

Tubo Pressão Direção Hidráulica Santana 84/96



**2511**

547422891

Flexível Retorno Dir Hidráulica Logus/ Verona/ 1.8 c/  
Ar e s/ Ar 92/96



**2512**

547422893

Flexível Direção Hidráulica Logus / Verona 92/94 /  
Pointer s/ Sensor

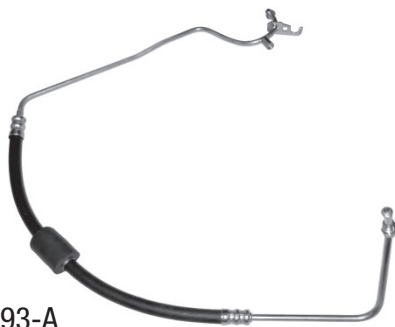

**2513**

547.422.893-A

Flexível Direção Hidráulica Logus / Escort c/ Sensor  
92/94



**2514**

6KE422.893-A / 6K1422.893-C

Flexível Direção Hidráulica Polo Classic Argentino  
96/00

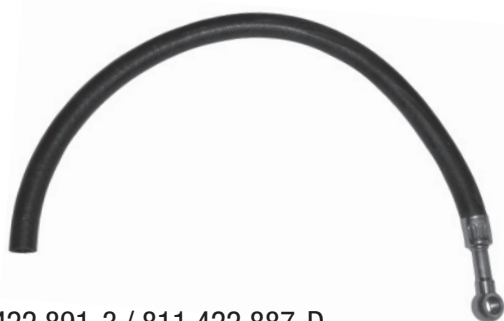

**2515**

325.422.891-3 / 811.422.887-D

Flexível Retorno da Caixa Direção Hidráulica Santana  
/ Quantum 96



**2516**

811.422.891-A

Flexível Retorno Santana / Versailles c/ Ar e s/ Ar 84/  
90

## Direção hidráulica Volks Passeio



**2517**  
1H1 422.893-G  
Flexível Direção Hidráulica Golf Imp. GLM / GLX /  
GLA / GTI 94/98



**2518**  
377.422.893-G  
Flexível Dir. Hid. Gol Bolinha Motor Ap 2000 Digital  
96/97 / Parati c/ Sensor 16v



**2519**  
377.422.893-B  
Flexível Direção Hidráulica Gol Motor Ap2000 EFI/  
MPFI 16v - 95/99



**2520**  
325.422.887-5  
Mangueira Alimentação Bba. Óleo Direção Hidráulica  
Santana 96/98



**2521**  
377.422.877-H  
Flexível Alimentação Gol Motor AC 1000 EFI Digital  
8/16v 97/98 / Parati



**2522**  
377.722.891-D  
Flexível Retorno Gol/ Saveiro/ Parati 95/97



**2523**  
377.422.893-N  
Flexível Direção Hidráulica Gol / Parati Motor AT  
1000 EFI Digital 8/16v 97/97



**2524**  
305.422.891-A  
Flexível Retorno Gol/ Parati/ Pointer 93/ 95



**2525**  
377.422.893-C  
Flexível Direção Hidráulica Gol Bolinha / Parati c/  
Sensor 96... 8V



**2526**  
377.422.887-A  
Mangueira da Alimentação da Bba. Óleo Gol 96/ 97



**2527**  
377.422.893-AB  
Flexível de Pressão Gol / Gol GTI 2.0 16v - 2000



**2528**  
547.422.887-A  
Flexível de Alimentação Logus - Todos



**2529**  
377.422.893-AA  
Flexível Direção Hidráulica Gol Geração III



**2530**  
325.422.877-2  
Mangueira de Alimentação Santana / Quantum



**2531**  
377.422.893-AB  
Flexível Direção Hidráulica Gol 2.0 16v 2000...



**2532**  
6K1422891-C / 6KE422891A  
Flexível Retorno Direção Hidráulica Polo Argentino  
96/00

## Direção hidráulica Volks Passeio

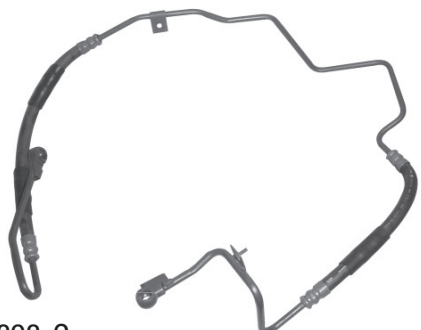

**2533**  
5ZO.422893-G  
Direção Hidráulica Fox s/ Ar 03...



**2534**  
5ZO.422893-B  
Direção Hidráulica Fox c/ Ar 03...



**2535**  
5ZO.422.887-A  
Alimentação Fox s/ Ar 03...



**2536**  
5ZO.422.887-D  
Alimentação Fox c/ Ar 03...



**2537**  
5ZO.422.891-A  
Retorno Fox c/ Ar s/ Ar 03...



**2538**  
542.422.887  
Alimentação Apollo / Escort – Lado Reservatório



**2539**  
6KI-422.893-L  
Pressão – Seat Cordoba 99/...

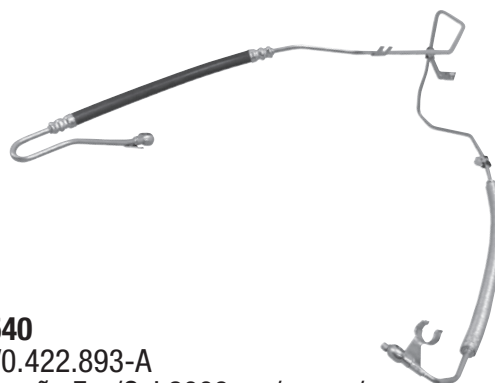

**2540**  
5V0.422.893-A  
Pressão Fox/Gol 2008... c/ ar e s/ ar



**2541**

5V1.422.887

Alimentação Fox/Gol 2008... c/ ar e s/ ar



**2542**

5Z0.422.891-E

Retorno Fox/Gol 2008... c/ ar e s/ ar



## Direção hidráulica Volks Utilitários e Caminhões



**2601**  
T07145357  
Mangueira Retorno Caminhão Volks



**2602**  
T07145745A  
Flexível de Pressão Caminhão Volks



**2603**  
T16145745  
Flexível de Pressão Caminhão Volks 14210 / 16210



**2604**  
TAR145745  
Flexível de Pressão Ônibus



**2605**  
TEG145745B  
Flexível de Pressão Bomba à Caixa Caminhão Volks 8140



**2606**  
TJG145745B  
Flexível de Pressão Caminhão 14220/16170/16220/  
24220/24250



**2607**  
2SB145357D  
Mangueira de Pressão Caminhão 14220/16170/1620/  
24220/24250



**2608**  
T11145745A  
Flexível de Pressão Caminhão Volks 87/88

## Direção hidráulica Volks Utilitários e Caminhões



**2609**  
TE03145745A  
Flexível de Pressão Caminhão Volks



**2610**  
T13607304  
Flexível do Freio a Ar Dianteiro Caminhão Volks  
13130



**2611**  
T00721483  
Flexível da Embreagem com 340 mm



**2612**  
TAF145459  
Flexível de Lubrificação da Turbina Ônibus 16180/  
Caminhão 14150 - c/ Flange



**2613**  
2RE721479A  
Flexível de Lubrificação da Turbina Caminhão 7140/  
8140 - c/ Flange



**2614**  
2RE721479A  
Flexível da Embreagem Caminhão Volks 12140

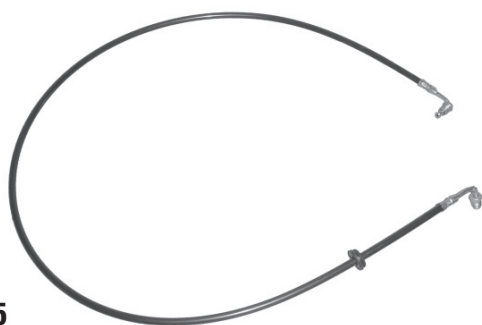

**2615**  
2SB721479  
Embreagem Ford Sapão F12000/ F14000



**2616**  
TNR607305  
Freio a Ar Diant. F12000/F14000/ Sapão 92...



**2617**  
2RL121.070 / N Cummins: 33.550.088  
Mangueira Entrada D'Água 16.170/ 3.5 - 93...



**2619**  
2RL.121.072  
Água Compre. 16.170/ 12.170/ 14.170 BT.



**2620**  
TAR.142.357  
Bomba ao Reserv. 14.200/14.140H/14.150/12.180



**2621**  
2TK.145.179  
Tubo Ret. Bomba ao Reserv. 13.150/13.170/13.180



**2622**  
2VR.145.177  
Tubo Pres. Bomba ao Reserv. 17.210/12.220/  
17.300



**2623**  
2TD.145.177-A  
Tubo Pres. Bomba ao Reserv. 17.210/18.310/  
26.300/24.220



**2624**  
2VR.145.179  
Tubo Ret. Bomba ao Reserv. 13.150/15.170/  
15.180/17.210



**2625**  
TAR.607.312-C  
Tubo Compres. de Ar Freio 16.180/16.210

## Direção Hidráulica Volks Utilitários e caminhões

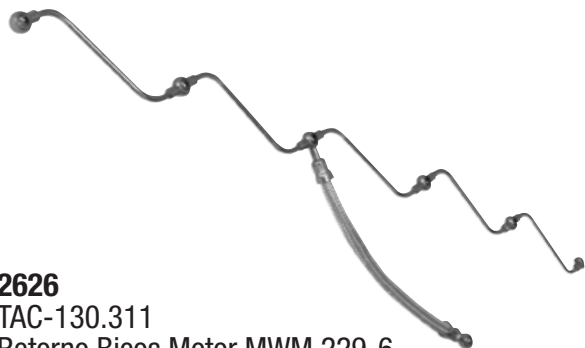

**2626**  
TAC-130.311  
Retorno Bicos Motor MWM 229-6

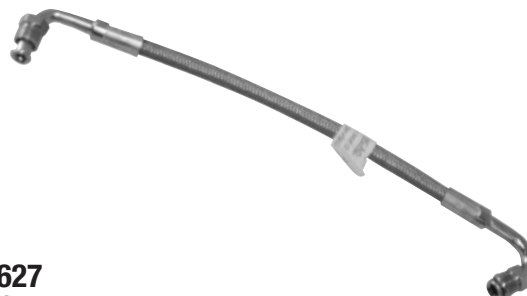

**2627**  
BCB BTAA  
Flex. Turbo Volks 17.210 / 2.320 - Cummins

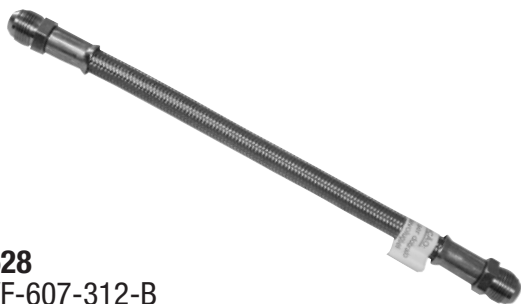

**2628**  
2VF-607-312-B  
Flex. Compressor Ar - Todos

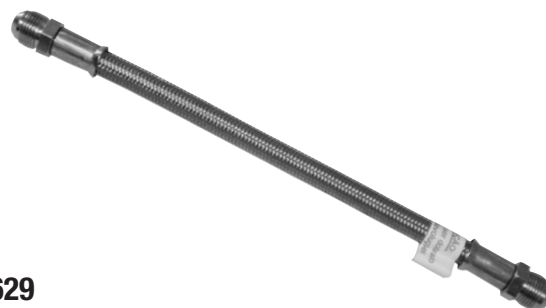

**2629**  
TRA-145-745  
Flex. Bomba Hidr. Caminhão - Todos

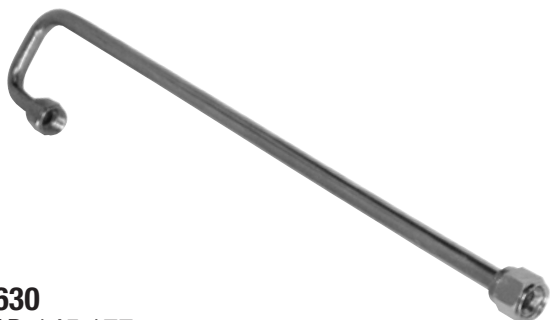

**2630**  
TAP-145.177  
Tubo Pres. 8150 / 9150 / 8100 / L80

# Direção Hidráulica



**FREIOCAR** 



**2701**  
09.301.210 / 94.644.468  
Flexível Retorno Opala/Caravan-4/6 Cil. - 75/92

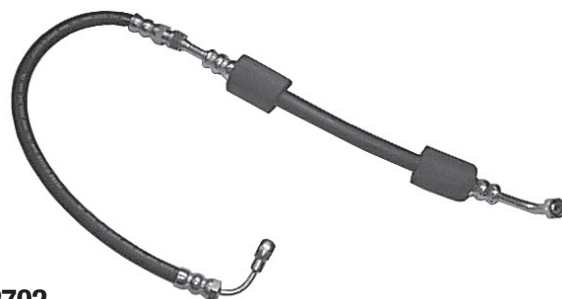

**2702**  
9.305.554  
Flexível Direção Hidráulica Opala até 01/90 - 75/84



**2703**  
52.256.785  
Flexível Direção Hidráulica Opala após 01/90 - 91/92



**2704**  
52.256.804  
Flexível Dir. Hidráulica Monza SLE/GLS/Sedan Classic 89/90 s/ Ar



**2705**  
52.256.805 / 52.256.828  
Flexível Direção Hidráulica Monza 89/90 C/ Ar - SLE/GLS/Sedan Classic



**2706**  
52256806/52256807/52267125  
Flexível Retorno Monza Classic 90/93-4 Cil. MPFI - 2L



**2707**  
52.267.125  
Flexível Retorno Bomba Ao Reserv. Monza SLE/GLS/Sedan Classic 89/90



**2708**  
52.267.126  
Flexível Retorno Monza / Kadet / Ipanema SL/ SLE/GLS - 91/98 EFI

## Direção hidráulica GM passeio



**2709**  
52.282.328  
Flexível Direção Hidráulica Monza/Kadet/Ipanema  
SL/SLE/GLS - 91/98 EFI



**2710**  
90.342.013  
Flexível Direção Hidráulica Omega 4 cil - 2L MPFI 8V  
GL/GLS - 93/93 s/ Ar



**2711**  
90.342.016  
Flexível Retorno Omega 4 Cil. GI/ GLS-2L/MPFI 8V c/  
ar e s/ar 93 /95



**2712**  
90.425.909  
Flexível Direção Hidráulica Vectra/Calibra 94/95

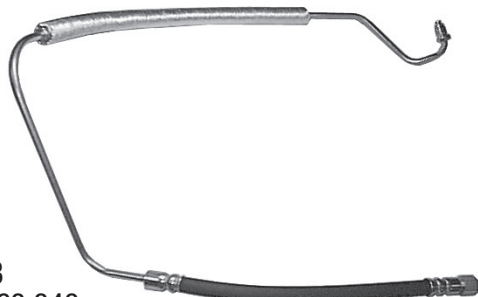

**2713**  
90.468.848  
Flexível Direção Hidráulica Corsa 95/96 s/ ar-c/ ar  
Tigrá 98/8



**2714**  
93.214.315  
Flexível Direção Hidráulica Omega/95...GLS/CD - 4.1  
- 6 Cil.



**2715**  
94.634.040  
Flexível Direção Hidráulica Monza SLE/ GLS/ Sedan  
Classic 83/89



**2716**  
94.634.041  
Flexível Retorno Monza SLE/GLS Sedan Classic  
83/89



**2717**

94.636.434

Flexível Direção Hidráulica SL/SLE/GLS - 91/98 EFI  
- Monza Classic c/ ar 83/89



**2718**

94.644.453

Manguera Sucção Reservatório Kadet GSI 92/95



**2719**

93.206.764

Flexível da Transmissão do Câmbio Ômega 4.1



**2720**

93.223.824

Flexível Direção Hidráulica Omega 95/98 - 2,2L -  
4 cil. c/ ar



**2721**

90.342.015

Flexível Direção Hidráulica Omega/Suprema c/ar e  
s/ar - 93/94



**2722**

93.214.316

Flexível Retorno Dir. Hidráulica Ômega 3.0 - 93/98  
- 6 cil 4.1 I - MPFI



**2723**

90.473.868 - NR.DHB-1.976.001

Flexível Direção Hidráulica Corsa 97/99



**2724**

90473857 - Nº DHB-1533009/1822026

Manguera Retorno Direção Hidráulica Corsa/Tigra  
s/ ar





**2725**  
93.203.634  
Flexível Direção Hidráulica Opala/Caravan 91/92 - 4  
Cil. 2,5 l - 6 Cil. 4,1 l

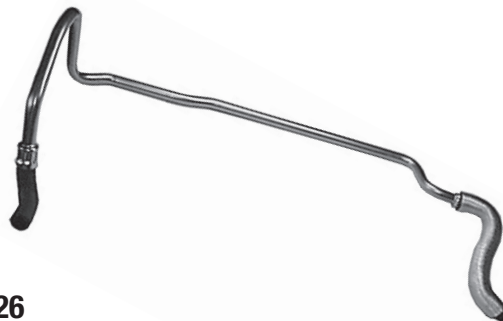

**2726**  
90.473.857 - NR. DHB 1.533.012  
Flexível Sucção Corsa/Tigra 95/98



**2727**  
94.655.761  
Mangueira Sucção Reservatório Opala/Caravan 6 cil.  
4.1 l - 87/92



**2728**  
52.253.351  
Mangueira Alimentação Opala/Caravan 4 cil. - 2.5 l  
90/92



**2729**  
90.473.806  
Mangueira Retorno Direção Hidráulica Corsa c/ ar



**2730**  
90.538.398  
Flexível Direção Hidráulica Vectra c/s ar 97... GL/  
GLS/CD



**2731**  
90.539.407  
Flexível Retorno Refr. Óleo Direção Hidráulica Vectra  
97...



**2732**  
93.206.765  
Flexível do Câmbio Ômega Automático



**2733**  
90.425.961  
Tubo Retorno Corsa/Tigra 95/99



**2734**  
90.473.856  
Tubo Pressão Corsa 95/99



**2735**  
NR. DHM 1822025  
Flexível Sucção Corsa c/ ar



**2736**  
90.342.878  
Mangueira Alimentação Ômega/ Suprema c/ ar 3.0  
- 6 cil. 93/94

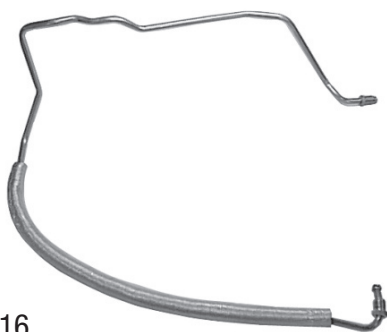

**2737**  
90.373.316  
Flexível Dir. Hidráulica Ômega c/ ar / Suprema 3.0  
- 6 cil. 93/94



**2738**  
90.373.317  
Flexível Retorno Ômega/Suprema c/ ar 3.0 - 6 cil.  
93/94



**2739**  
90.473.964  
Flexível Direção Hidráulica Vectra/Calibra 94/96

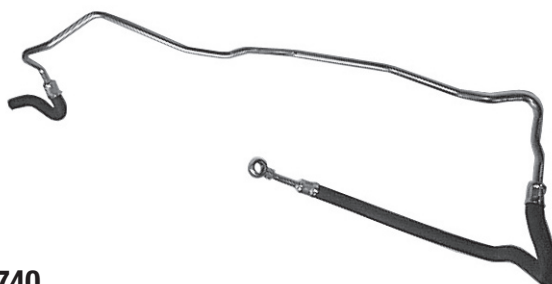

**2740**  
90.539.508  
Flexível Retorno Óleo Direção Hidráulica Vectra 97..



**2741**  
93.206.605  
Mangueira Sucção Omega 4.1L 6 cil. c/ ar - 93/98



**2742**  
93.208.671  
Mangueira Tubo ao Reservatório Ômega 4.1 6 cl. - 93/98



**2743**  
93.213.090  
Flexível Retorno Direção Hidráulica Kadet/Monza/Ipanema SD/SLE/GLS 4 cil. 2.0 I MPFI 8 I - 97/98



**2744**  
52.257.285  
Flexível Alimentação Monza/Kadet



**2745**  
52.257.286  
Flexível Retorno da Injeção Monza/Kadett



**2746**  
26.059.299  
Flexível Direção Hidráulica Astra Caixa TRW Eletro-hidráulica 4 cil 2.0 I MPFI 16V 1.8 I MPFI 8V - 99/99



**2747**  
26.059.200/ 09.118.137  
Flexível Retorno Astra Caixa TRW Eletro-hidráulico 99/99 4 cil. 2.0I MPFI 16v



**2748**  
93.322.498  
Flexível Retorno Celta c/ ar e s/ ar 01...

## Direção hidráulica GM passeio



**2749**  
93.322.496  
Flexível Direção Hidráulica Celta s/ ar 01...



**2750**  
1.842.003 / 93.322.501  
Flexível de Sucção Celta s/ ar 01...



**2751**  
1.842.004/ 93.322.497  
Tubo de Pressão Celta c/ ar e s/ ar - 01...



**2752**  
DHB 1.827.511  
Flexível Sucção Celta c/ ar 01...



**2753**  
DHB 1.827.512  
Flexível Direção Hidráulica Celta c/ ar - 01...

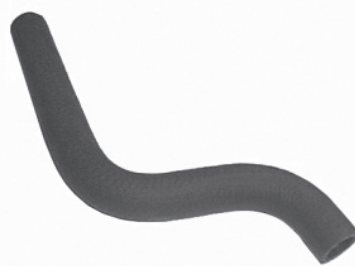

**2754**  
90.235.633  
Mangueira Alimentação Ômega/Suprema 4 cil. 2.0 l 8 V s/ ar 93/95



**2755**  
90.278.687  
Mangueira Alim. Ômega/Suprema 4 cil. - 2.0 MPFI 8 V s/ar 93/93



**2756**  
90.034.922  
Mangueira Água Aquecimento Monza com Ar e Ar Quente



**2757**  
90.468.254  
Flexível Direção Hidráulica Astra Lado Bba. 95/96  
c/ ar

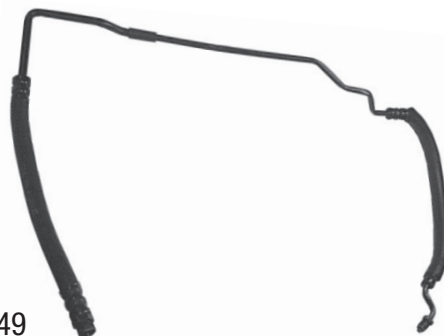

**2758**  
93.283.749  
Flexível Direção Hidráulica Astra/Zafira Convencional  
99... Caixa DHB



**2759**  
93.366.879  
Flexível de Pressão Corsa 2002

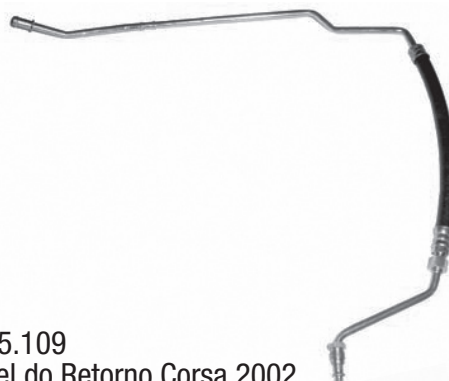

**2760**  
93.285.109  
Flexível do Retorno Corsa 2002



**2761**  
93.361.777  
Flexível de Refrigeração Óleo Direção Hidráulica  
Corsa 2002



**2762**  
93.265.107  
Flexível de Alimentação Corsa 2002



**2763**  
DHB 1.849.002  
Pressão Astra 2002 - Caixa DHB

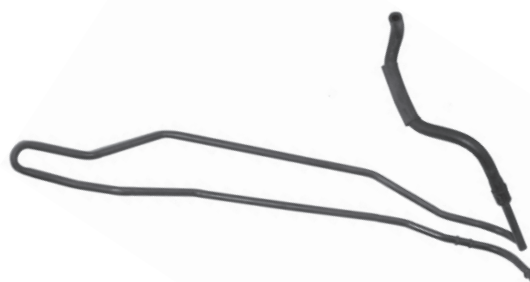

**2764**  
DHB 1.849.003  
Retorno Lado Bomba Astra 2002 Caixa DHB

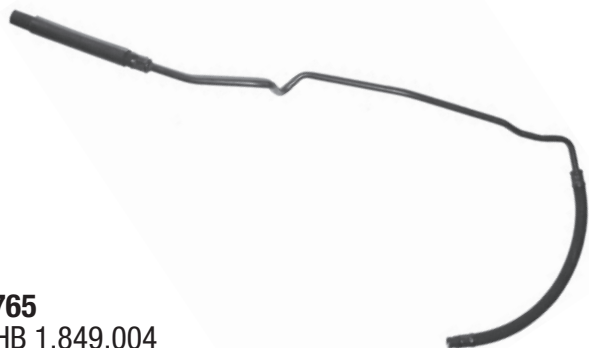

**2765**  
DHB 1.849.004  
Alimentação Astra 2002 - Caixa DHB



**2766**  
93.392.885  
Pressão Meriva 2003...



**2767**  
93.303.438  
Pressão Astra 2004...



**2768**  
93.303.432  
Retorno Astra 2004...



**2769**  
93.376.583  
Alimentação Astra 2004...

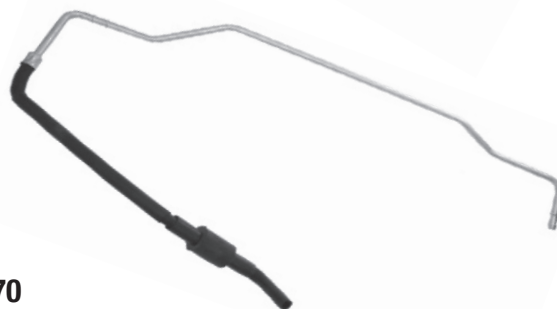

**2770**  
93.303.430  
Cooler Astra 2004...



**2771**  
93.340.669  
Direção Hidráulica Celta Totalflex s/ Ar



**2772**  
93.340.670  
Alimentação Celta Totalflex s/ Ar



**2773**  
Direção Hidráulica Celta Totalflex s/ Ar - Caixa DHB



**2774**  
Alimentação Celta Totalflex s/ Ar Caixa DHB



**2775**  
Direção Hidráulica Celta Totalflex c/ Ar Caixa DHB



**2776**  
Alimentação Celta Totalflex c/ Ar Caixa DHB



**2777**  
7.316.839  
Transmissão Óleo Opala - Terminal Longo



**2778**  
52.284.041 - Flexível Entrada de Óleo Monza / Kadet / Ipanema - 85/95



**2779**  
52.284.042 - Flexível Saída de Óleo Monza / Kadet / Ipanema - 85/95



**2780**  
52.267.565 - Flexível Tanque Combustível Kadet / Ipanema / Monza / S-10 - 91/98

## Direção hidráulica GM passeio



**2781**  
DHB 93.383.086 - Flexível Direção Hidráulica Celta Totalflex 2007 / Celta Flex / Prisma S/Ar - 2002/...



**2782**  
DHB 93.383.087 - Flexível Alimentação Celta Totalflex 2007 / Celta Flex / Prisma S/Ar - 2002/...



**2783**  
DHB 93.386.518 - Flexível Retorno Celta Totalflex 2007 / Celta Flex / Prisma S/Ar - 2002/...



**2784**  
Tubo Pressão Celta Totalflex 2007 / Celta Flex / Prisma S/Ar - 2002/...

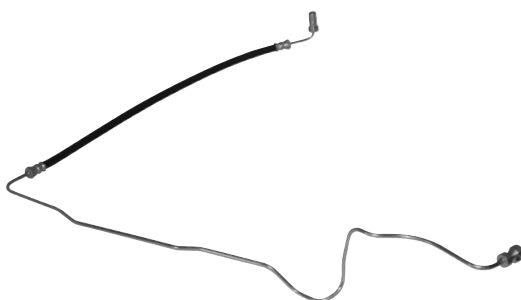

**2785**  
90.206.775 / 90.343.638 - Flexível Embreagem Omega 3.0 / 4.1 - 93/98 - 6 Cilindros



**2786**  
93.338.694  
Pressão Corsa Classic



**2787**  
93.312.923  
Alimentação Meriva - 2003 /...

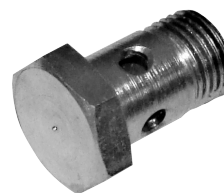

**2788**  
16.290.106  
Parafuso Oco 16 x 1,5 curto Monza e outros



## Direção hidráulica GM utilitários e caminhões



**2801**  
7.327.072  
Flexível Retororno Direção Hidráulica D-60 Canav.  
81/82



**2802**  
7.327.073  
Flexível Bomba Hidráulica ao Filtro D-60/70 -  
Perkins 70/ 80



**2803**  
7.327.075  
Flexível Direção Hidráulica a Val. D-60 - Canavieiro  
81/84



**2804**  
7.327.077  
Flexível Direção Hidráulica Válvula ao Filtro D-60  
81/84



**2805**  
7.331.116  
Flexível Direção Hidráulica Veraneio/C-14



**2806**  
7.331.248  
Flexível Retorno Veraneio/Pick-up/D-10/C-10 - 73/84



**2807**  
52.257.080  
Flexível Retorno D-20 Moderno C-20 c/ Setor DHB



**2808**  
52.262.666  
Flexível Direção Hidráulica Progressiva C-20 - 6 cil.  
91... 4.1 l

## Direção hidráulica GM utilitários e caminhões



**2809**  
52.262.667  
Flexível Direção Hidráulica D-20 / Veraneio 91/ 96

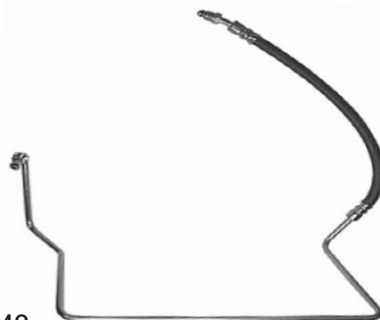

**2810**  
93.220.149  
Flexível Direção Hidráulica S-10/ Blazer 4 cil. - 2.2 l  
EFI 95/00



**2811**  
93.220.150  
Flexível Direção Hidráulica S10 - 4 cil.



**2812**  
94.601.651  
Flexível Direção Hidráulica D-60 - Detroit - 79/79



**2813**  
94.602.108  
Flexível Retorno Direção Hidráulica D-60  
Detroit-79/79



**2814**  
94.603.833  
Flexível Direção Válvula ao Cilindro D-60/D-80 79/82



**2815**  
94.609.114  
Flexível Direção Hidráulica D-10 Sentido Contrário



**2816**  
94.609.336  
Flexível Retorno Cilindro à Válvula D-60/D-70  
79/84-INF

## Direção hidráulica GM utilitários e caminhões



**2817**  
94.620.906 - BBA.DHB  
Flexível Retorno Direção Hidráulica A-60/ A-70/  
C-10 - 81/84



**2818**  
94.623.420  
Flexível Direção Hidráulica A-10/A-14C-85...



**2819**  
94.631.596  
Flexível Direção Hidráulica AC-13/ 20-D/40 Caixa  
DHB - 85/97



**2820**  
94.631.597  
Flexível Direção Hidráulica D-20 - 85 Todos



**2821**  
94.631.597 / 52.262.666  
Flexível Direção Hidráulica D-20 Antiga



**2822**  
94.631.598  
Flexível Direção Hidráulica A-40/ C-40 85/95



**2823**  
94.643.110  
Flexível Direção Hidráulica D-60 11000/ 12000  
- 85/96



**2824**  
94.643.113  
Flexível Direção Hidráulica D-11000/ 12000/ 13000/  
14000/ 19000/ 21000/ 22000 - 85/96 - Motor Perkins

## Direção hidráulica GM utilitários e caminhões



**2825**  
94.651.691  
Manguera Retorno D-20/ C-70 c/ ar 85/90



**2826**  
93.243.641  
Flexível Direção Hidráulica Silverado/ Grand Blazer 6 cil. 4.1 l Cil. - 97/99



**2827**  
26042259  
Flexível Direção Hidráulica Blazer/S-10 4.3L MPFI - 6 Cil. 96/01



**2828**  
93.220.164  
Flexível Retorno Direção S-10/Blazer GAS.2.2 l - 95/02 4 cil.



**2829**  
93.234.514  
Flexível Direção Hidráulica S-10/ Blazer - 4 cil. 2.5 l 96/00



**2830**  
94.609.335  
Flexível Pressão do Cilindro à Válvula D-60/ D-70/ D-80 79/84



**2831**  
94.621.247  
Flexível Direção Hidráulica D-60/ D-70/ D-80 81/84



**2832**  
MWM 90106  
Flexível de Lubrificação do Turbo Silverado

## Direção hidráulica GM utilitários e caminhões



**2833**  
MWM 90107  
Flexível de Retorno Lubrificação do Turbo Silverado



**2834**  
93.243.641  
Flexível Direção Hidráulica S-10/ Blazer até 95 Importada



**2835**  
93.284.354  
Direção Hidráulica S10/ Blaser/ Turbo 2.8 - 00...



**2837**  
94.649.685  
Mangueira Sucção D20/ C70 - 85/90



**2838**  
52.257.114  
Mangueira Sucção D20/ D40 - 93/97



**2839**  
70.992.506  
Flexível Lubrificação Turbo D-20 Motor Maxion



**2840**  
70.200.845  
Flexível Saída Bloco S-10 Motor Maxion HS



**2841**  
70.200.846  
Flexível Entrada Resfriador S-10 Motor Maxion HS

## Direção Hidráulica



**FREIOCAR** 



**2901**  
60563917  
Flexível Direção Hidráulica Alfa164 - 3000 cc V6  
12 V - 90/97



**2902**  
7077625  
Flexível Direção Hidráulica Tempra 2000 cc MPI 16v  
92/96 c/ Ar



**2903**  
7715283  
Flexível Direção Hidráulica Tempra 2000cc  
s/ Ar 92/ 93



**2904**  
46.476.086 / 7.728.404  
Flexível Direção Hidráulica Tipo 1.6 MPI 1600 cc SPI/  
MPI 93/97



**2905**  
82491301/2 / 40083.180/181  
Flexível Retorno do Palio EL 1500/1600cc 16 v MPI  
1000 cc MPI - 96/00



**2906**  
40083182  
Mangueira Alimentação Palio 1.0/ 1.5/ 1.6 16v c/ Ar e  
s/ Ar - 96/...

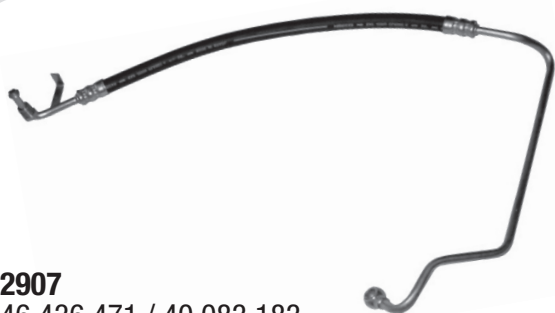

**2907**  
46.436.471 / 40.083.183  
Flexível Dir. Hid. Palio EL-1500 cc MPI GS-96/98  
- EDX-1000 cc MPI GS - 96/99



**2908**  
46404062  
Flexível Direção Hidráulica Tipo 2.0 16v1 MPI 94/95



**2909**  
46480311  
Flex. Ret. Dir. Hidráulica Palio Strada Working  
1500/1600cc MPI GS 99/00

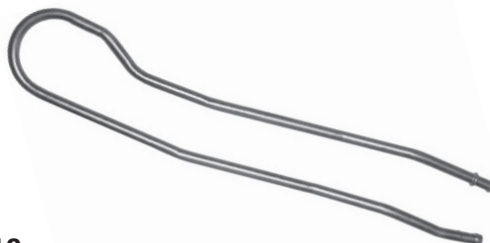

**2910**  
46540451  
Tubo Refrigeração Óleo Palio Strada 1500/1600 cc  
MPI 16 v 99/01

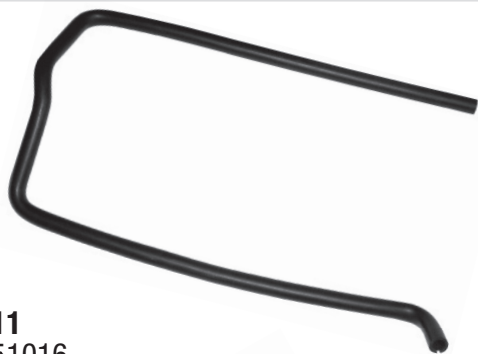

**2911**  
7751016  
Mangueira Retorno Direção Hidráulica Tempra Todos



**2912**  
7715281  
Mangueira Alimentação Tempra Todos



**2913**  
82491302  
Flexível Ret Palio/Palio Weekend/Strada/Siena 1.0/  
1.5/1.6 MPI 97/00



**2914**  
82491312  
Flexível Retorno Palio 1000/1500/1600 cc - Novo  
Palio 8/16v - 96...

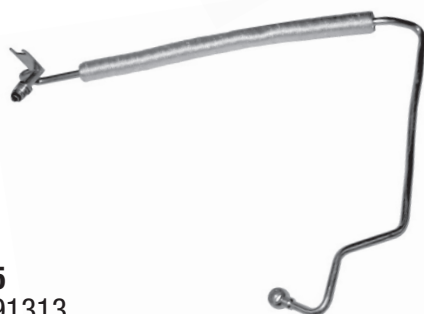

**2915**  
82491313  
Flexível Dir. Hidr. Palio/Siena/ Weekend/ Strada 1600  
cc 16 v MPI 96/01



**2916**  
82491393  
Mangueira Alimentação Palio/Palio Weekend 1.6 16v  
MPI - 96/00





**2917**  
60595418  
Flexível Direção Hidráulica Alfa 164 Super 3000 cc  
V6 24 v - 95/97



**2918**  
5951133  
Parafuso Oco 12 mm Palio/Palio Weekend/Novo Palio  
Weekend 98...



**2919**  
46760320  
Flex. Dir. Hidr. Palio ELX 1000/1300/1600 cc MPI 8/  
16 v Fire GS-2001...



**2920**  
46760321  
Mangueira de Alimentação do Palio 1500/ 1600  
- MPI - 99/01



**2921**  
46520716  
Flexível Retorno Direção Hidráulica Palio Motor Fire  
MPI 8/16 v 01...



**2922**  
93.825.643  
Flexível Retorno Daily 3510 Iveco



**2923**  
93.826.716 / 93.822.396  
Flexível Direção Hidráulica Iveco Daily



**2924**  
60619754  
Flex. D.H. Alfa 145-2.0 TS 16v GS - 96/99 - 155/155  
Super 2.0 TS 16 v GS - 95/98



**2925**  
DHB 1.851.003  
Flexível de Pressão Uno Fire Caixa DHB



**2926**  
DHB 1.851.004  
Flexível de Retorno Uno Fire Caixa DHB



**2927**  
DHB 1.851.005  
Flexível de Alimentação Uno Fire Caixa DHB



**2928**  
DHB 1.851.006  
Tubo de Pressão Uno Fire Caixa DHB



**2929**  
DHB 1.851.007  
Niple Uno Fire Caixa DHB



**2930**  
DHB 1.851.008  
Tubo de Retorno Uno Fire Caixa DHB



**2931**  
50.007.518  
Tipo Pressão c/ Olhal



**2932**  
98.464.157  
Embreamento EuroCargo Iveco



**2933**  
93.162.025-A  
Tubo Retorno Caixa Direção Hidráulica Iveco Maior



**2934**  
93.162.025-B  
Tubo Retorno Caixa Direção Hidráulica Iveco Menor



**2935**  
60.625.884.80  
Pressão - Dir. Hidráulica Alfa 145-T Spake



**2936**  
Tubo Dir. Hidráulica Tempra - Todos

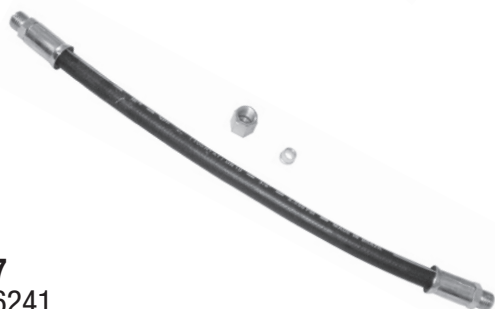

**2937**  
4726241  
Flexível Embreagem Iveco



**2938**  
51.746.922  
Pressão Palio 1.8 / 2004... - Cx. TRW



**2939**  
93.394.738  
Alimentação Palio 1.8 / 2004... - Cx. TRW



**2940**  
93.394.738A  
Retorno Palio 1.8 / 2004... - Cx. TRW



**2941**  
46.480.311  
Retorno Palio 1.8 / 2004... - Cx. TRW



**2942**  
51.732.519  
Retorno Palio 1.8 / 2004... - Cx. TRW - Lado da Bomba



**2943**  
Parafuso Oco Palio 1.8 / 2004... - Cx. TRW



**2944**  
Alimentação Tipo 1.6

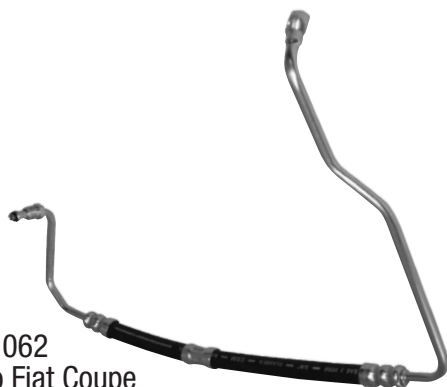

**2945**  
46.404.062  
Pressão Fiat Coupe



**2946**  
41.013.610  
Flexível Alavanca Fiat Iveco



**2947**  
46.528.548  
Pressão Brava 1.6 - 16 V - 00/03



**2948**  
Pressão Alfa 156

## Direção Hidráulica



## Direção hidráulica Toyota Bandeirante

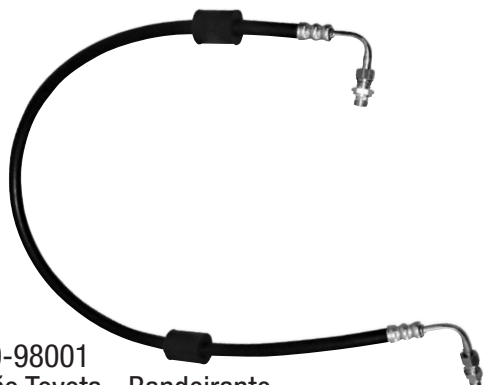

**1706**  
44410-98001  
Pressão Toyota - Bandeirante



**1707**  
44427-98001  
Alimentação Toyota - Bandeirante



**1708**  
44406-98001  
Retorno Toyota Bandeirante

**Acessórios**

**Vans importadas**

**FREIOCAR** 



**1850**  
0054518712 A  
Flexível Alternador - Topic / Besta



**1851**  
37482-42100  
Flexível Alternador H-100



**1852**  
000.096.0290  
Lubrificação Turbina Sprinter Motor - HS - S-10



**1853**  
70992923  
Lubrificação Turbina Sprinter Motor - HS - S-10  
Olhal 12mm



**1854**  
000.238.0056  
Alternador Sprinter / F-1000 / Grande (Chapa)



**1855**  
013.63.18.722-B  
Mang. Moldada Retorno da Bomba do Carter Topic/  
Besta



**1856**  
709928890  
Alternador Sprinter Pequeno (Chapa)



**1867**  
000.096.0490  
Lubrificação da Turbina Sprinter 312 Olhal - 10mm





**1870**  
70620802  
Alternador Sprinter



**1871**  
70993008  
Alternador Sprinter



**1884**  
6.008.001.295.002  
Flexível Lub. Turbina Micro-Ônibus Volari Agrale



**1885**  
6.008.001.295.001  
Flexível Lub. Turbina Micro - Ônibus Volari Agrale

**Direção Hidráulica**

**Vans importadas**

**FREIOCAR** 

## Direção Hidráulica Vans Importadas



**1845**  
1.093.903-A  
Pressão BMW 325 - 96/00



**1846**  
1.141.954  
Pressão Direção Hidráulica BMW 535 - 94/00



**1847**  
Pressão Direção Hidráulica Crysler Stratus -  
4 Cilindros - 95/01



**1848**  
Pressão Direção Hidráulica Cherokee 3.3 - 2001/...



**1849**  
52088539 83044G  
Pressão Direção Hidráulica Gran Cherokee 5.2 -  
V8 - 95/02



**1857**  
AA 70 A 32420  
Flexível Direção Hidráulica Topic 96...



**1858**  
7702224220  
Flexível Direção Hidráulica Trafic

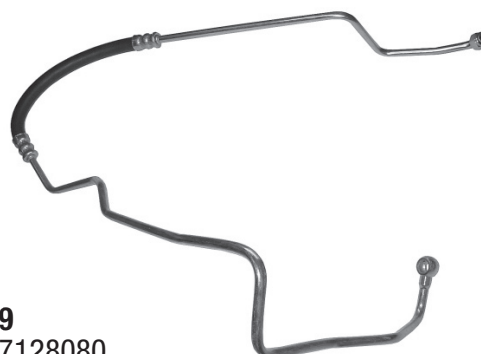

**1859**  
1317128080  
Flexível Direção Hidráulica Ducatto 2.2 Diesel

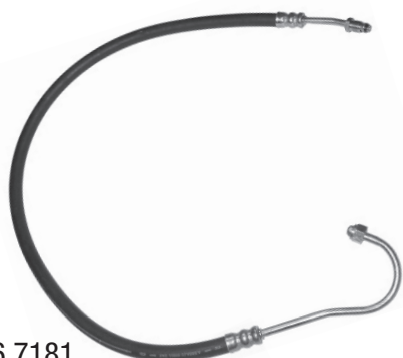

**1860**  
A 690.466.7181  
Direção Hidráulica Sprinter 310-D/ 312-D 412-D Maior



**1861**  
KA 65A14830  
Flexível Alternador Besta GS 2.2 / 2.7



**1862**  
57520.43020  
Flexível Direção Hidráulica Hyundai H-100



**1863**  
Flexível Direção Hidráulica Mitsubishi L-200



**1864**  
010013501701304  
Flexível Direção Hidráulica Lumina



**1865**  
Flexível Direção Hidráulica Citroen



**1866**  
000.238.0082  
Mangueira da Bomba Vácuo Sprinter 310-D / 312-D / 412-D



**1868**  
690.466.7181-A  
Flexível I Direção Hidráulica Sprinter Menor



**1869**  
KK61007101  
Flexível Direção Hidráulica Besta 96 Motor 2.7



**1872**  
Flexível Alimentação BMW 325 Até 97



**1873**  
058.145.778  
Flex.Lub.Turb.Audi A3/Passat/Passat / Variant -  
Motor 1.8 - 98/01



**1874**  
468432225517  
Flexível Direção Hidr.Dodge Caravan / Grand  
Caravan 3.3-96/98-LE



**1875**  
KK7F002101  
Flexível Direção Hidráulica H-100 Olhal - 14 mm



**1876**  
5208800783044G  
Direção Hidráulica Cherokee



**1877**  
4A1-422.893-L  
Flexível Direção Hidráulica Audi A6 98... - Pressão



**1878**  
8D1-422.893-M  
Flexível Direção Hidráulica Audi A4 98... - Pressão



**1879**  
8D1-422.891-J  
Flexível Direção Hidráulica Audi A4 98... - Retorno



**1880**  
8A1-422.893-D  
Flexível Direção Hidráulica Audi A3 99... - Pressão

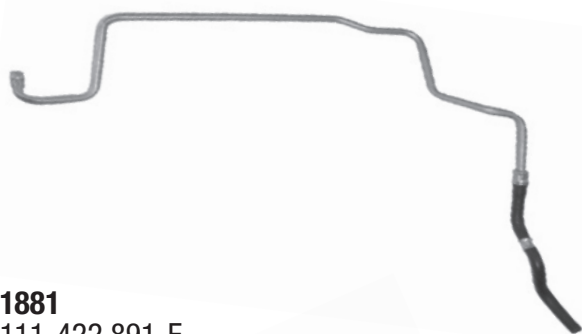

**1881**  
111-422.891-F  
Flexível Direção Hidráulica Audi A3 99... - Retorno



**1882**  
D1-422.893-L  
Flexível Direção Hidráulica Passat Alemão 1.8 - Turbo - 96/00 - Pressão



**1886**  
4A1422.893-Q  
Flexível D.H. Audi A-4

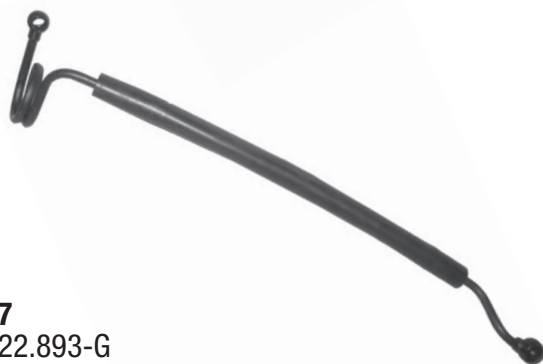

**1887**  
8A422.893-G  
Flexível D.H. Audi A4 Ano 94



**1888**  
K72ADE03  
Flexível D.H. Besta GS/ Grand



**1889**  
468432425517  
Flexível D.H. Caravan LX 3.8 - 4x4 - 98/02

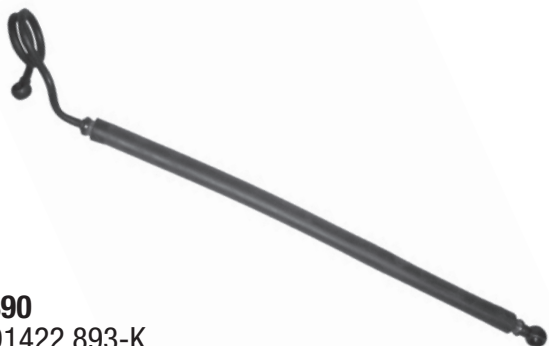

**1890**  
8D1422.893-K  
Flexível D.H Audi A4 1.8 Turbo 95



**1891**  
000.428.6835  
Flexível Embr. Sprinter 310-D/ 312-D/ 412-D

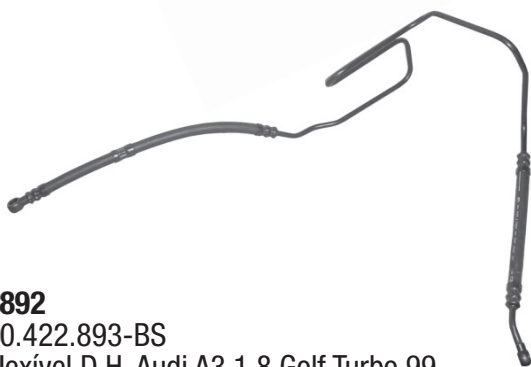

**1892**  
10.422.893-BS  
Flexível D.H. Audi A3 1.8 Golf Turbo 99...



**1893**  
164/98/138803  
Flexível D.H. BMW

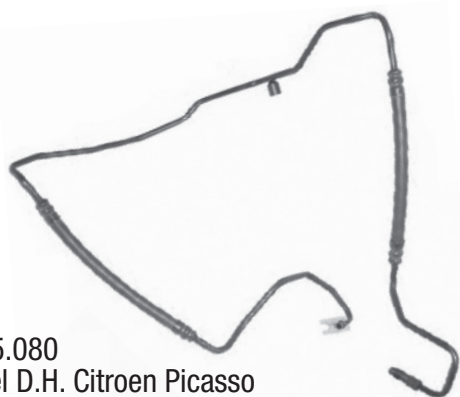

**1894**  
94.245.080  
Flexível D.H. Citroen Picasso



**1895**  
MR 491958  
Direção Hidráulica Pajero Full 3.5 98/03 gasolina



**1896**  
Direção Hidráulica Toyota Corolla - 94/97



**1897**  
1138101  
Direção Hidráulica BMW 325 - 90/95



**1898**

000.078.0481

Retorno Bicos Sprinter 310 / 312-D/ 412



**1899**

Flexível Turbina Audi / Passat

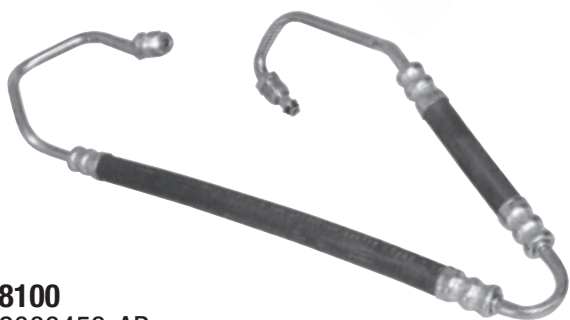

**18100**

32088453-AB

Pressão Gran Cherokee 8 valv. - 01/05

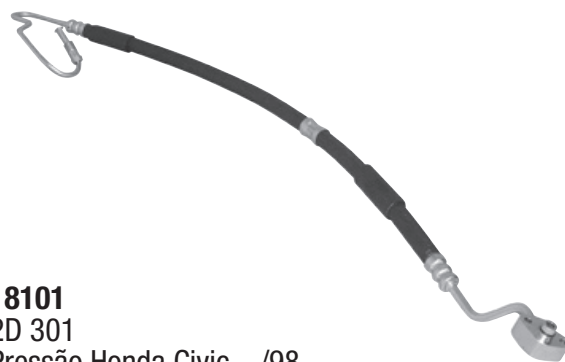

**18101**

2D 301

Pressão Honda Civic .../98



**18102**

Pressão Citroen Xsara 2.0/1.8 - 01...



**18103**

3ESX06

Pressão Honda Civic - 99... - c/ sensor



**18104**

ANR6656

Pressão Land Rover Discover



**18105**

52088489

Pressão Cherokee V.6 - 4.0 / L-3 / 01



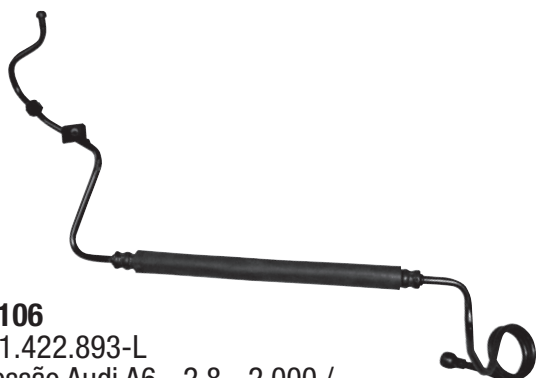

**18106**  
4B1.422.893-L  
Pressão Audi A6 - 2.8 - 2.000 /...



**18107**  
4B1.422.891  
Retorno Audi A6 - 2.8 - 2.000/...



**18108**  
06B/145/771P  
Lubrificação Turbina Audi A4 / Passat / Variant



**18109**  
4014ET  
Pressão Citroen C5 - 2000 / 2004



**18110**  
IJ422893DC  
Pressão Golf 1.8 Turbo / Bora / Audi A3

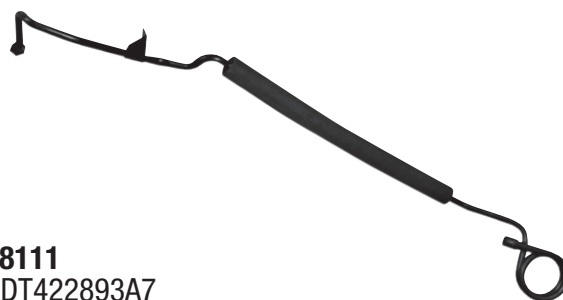

**18111**  
BDT422893A7  
Pressão Audi A6 / Passat 2.8 / 98/...



**18112**  
45713691TA  
Alimentação Mondeo 2.0 - 99/2001



**18113**  
53015181AA  
Pressão Cherokee 2.1 - 94 /... Diesel



**18114**  
Tubo de Retorno Xsara



**18115**  
Pressão Audi A3 / Golf Geração 4 - 1.8 / 2.0



**18116**  
XY8DY07  
Pressão Honda Civic - 97/... - sem sensor

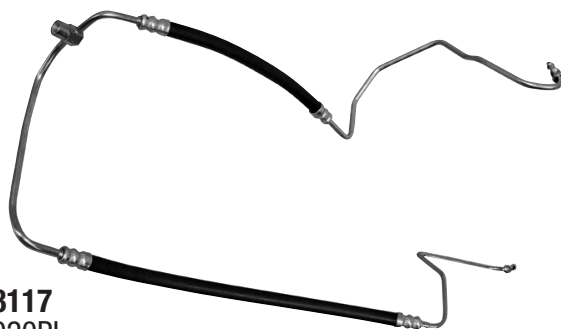

**18117**  
4020PL  
Pressão Berlingo 95/... Partner

## Direção Hidráulica



**PEUGEOT**



**RENAULT**

**FREIOCAR**

## Direção hidráulica Peugeot/Renault



**3803**  
4041G0/1852008  
Direção Hidráulica Peugeot 206 c/ Ar



**3804**  
Direção Hidráulica Peugeot 206 s/ Ar



**3805**  
401268 / DHB 1852009  
Retorno Peugeot 206 - C/Ar - S/Ar - DHB



**3806**  
401335 / DHB 1852012  
Retorno Peugeot 206 - C/Ar - S/Ar - DHB



**3807**  
401269 / DHB 1852010  
Alimentação Peugeot 206 - C/Ar - S/Ar - DHB



**3808**  
4014F9  
Alimentação Peugeot 206 - C/Ar - S/Ar - DHB



**3809**  
401337 / DHB 1852011  
Cooler Peugeot 206 - C/Ar - S/Ar - DHB

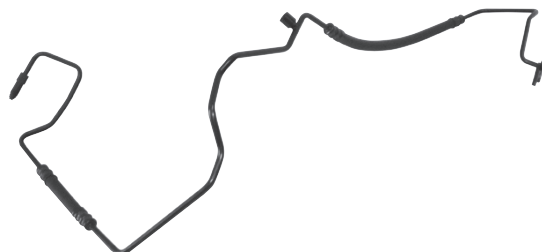

**3810**  
Pressão Peugeot 206 - 2000... - C/Sensor - C/Ar -  
Res. Acoplado

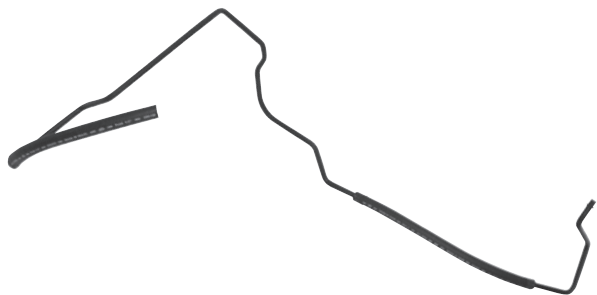

**3811**  
Retorno Peugeot 206 - 2000... C/Ar - Res. Acoplado



**3812**  
DHB 1852008  
Pressão Peugeot 206 - S/Sensor - C/Ar

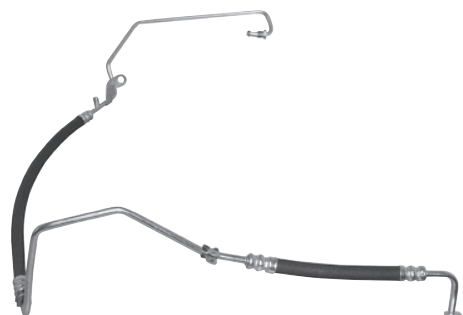

**3813**  
8200.530131  
Pressão Logan 1.0 - 2007... 16 valv. - s/ ar

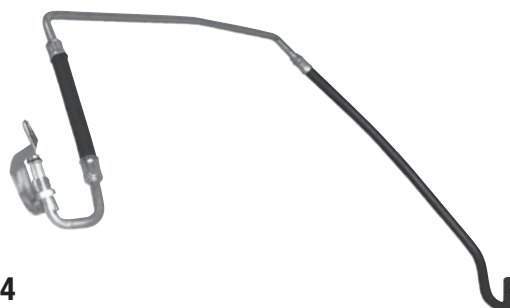

**3814**  
8200.530260  
Retorno Logan 1.0 - 2007... 16 valv. - s/ar



**3815**  
8200.530104  
Alimentação Logan 1.0 - 2007... - 16 valv. s/ ar



**3816**  
8200.530017  
Alimentação Logan 1.0 - 2007... - 16 valv. s/ ar



**3817**  
Pressão Clio



**3818**  
8200.530136  
Pressão Logan 1.0 - 2008... 16 valv. c/ ar



**3819**  
8200.132225  
Pressão Logan 1.6 - 2008... c/ ar



**3820**  
8200.615223  
Alimentação Logan 1.6 - 2008... c/ ar

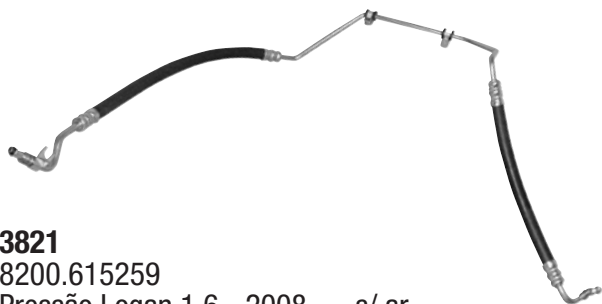

**3821**  
8200.615259  
Pressão Logan 1.6 - 2008... - s/ ar



**3822**  
8200.615219  
Alimentação Logan 1.6 - 2008... - s/ ar



**3823**  
8200.615288  
Retorno Logan 1.6 - 2008... - s/ ar - c/ ar



**3824**  
4014.C9/9638222480-D  
Pressão Peugeot 206 1.4 - s/ ar / c/ ar



**3825**  
4012.87/9638222180-F  
Retorno Peugeot 206 1.4 - s/ ar / c/ ar

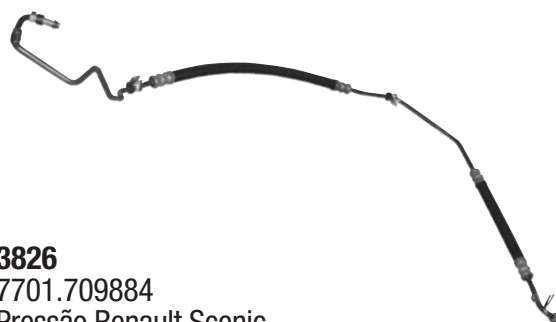

**3826**  
7701.709884  
Pressão Renault Scenic



**3827**  
7701.708119-A  
Pressão Renault Scenic 2.0 - 16 valv. - 2001

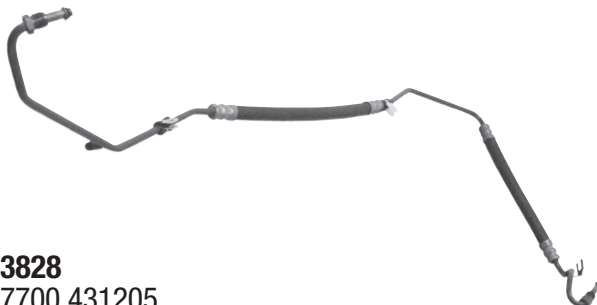

**3828**  
7700.431205  
Pressão Renault Scenic 95/99 - c/ ar



**3829**  
8200041630-D  
Pressão - Renault Master

**3830**  
8200041631-D  
Retorno - Renault Master

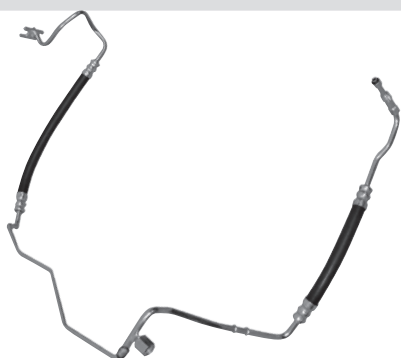

**3831**  
4014KJ  
Pressão - Peugeot 207 - 1.4 - s/ ar - c/ ar 2008 /...



**3832**  
1012R5  
Retorno Peugeot 207 - 1.4 / s/ ar - c/ ar



**3833**  
Pressão - Clio - s/ sensor - s/ ar 1.0 - 16V



**FREIOCAR** 

**Indústria de Flexíveis e Componentes Automotivos Ltda.**

Av. das Cerejeiras, 1.088 • Jardim Japão • São Paulo • SP  
CEP 02124-000 • Telefax (11) 2201-7109 / 2986-8617  
e-mail: [freiocar@terra.com.br](mailto:freiocar@terra.com.br)